

TRUBRITE™ WHITEBOARDS

Price Effective - January 1, 2024

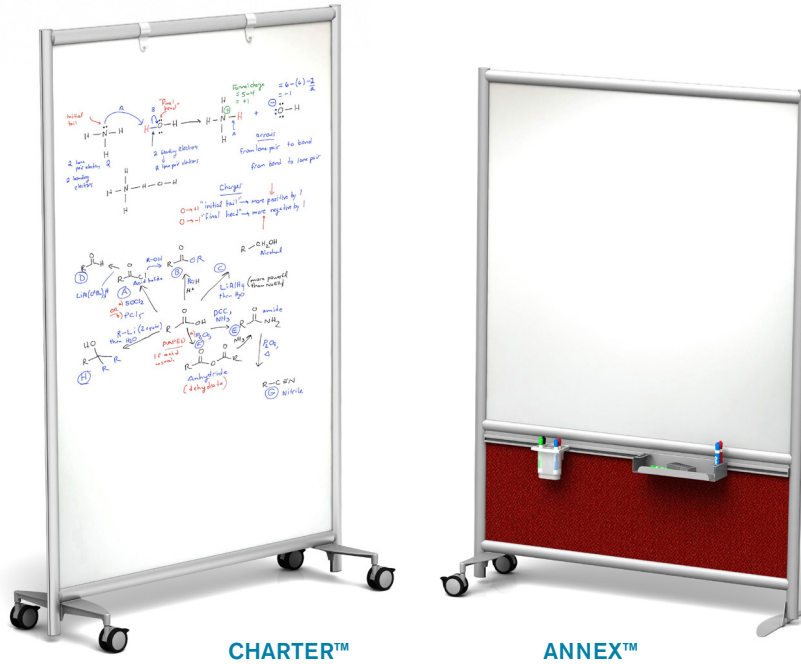

CHARTER™

ANNEX™

MOBILE DRY ERASE WHITEBOARD

Engineered to be lightweight, durable and mobile, our TruBrite™ Whiteboards are designed and built to share ideas. Our high-quality TruBrite™ dry-erase writing surface is non-ghosting, easy to clean and economical. TruBrite™ Whiteboards are available in 2 contemporary aluminum frame designs with mobile or free-standing foot options.

- Framework is constructed using aluminum extrusion
- All metal parts are anodized, or powder coated for an aesthetic and durable finish
- Our metal mobile feet have 3" locking casters
- Nesting frame design allows for easy space-saving storage
- TruBrite™ dry erase surface is non-ghosting and easy to clean
- Made in the USA

How to build your SKU:

Step 1:
Choose your Model

3SL

Step 2:
Choose your Width

49

Step 3:
Choose your Height

54

Step 4:
Choose your Frame Color

BK

Step 5:
Choose your Foot Option

4

Step 6:
Choose your Dry Erase Material

WB

Step 6:
Choose your Lower Core Material (Annex™ - 3SL only)

P103

(Annex - 3SL only)

TRUBRITE™ WHITEBOARDS

Model	Width	Height	Frame Color	Foot Options	Dry Erase Materials	Lower Core Materials (Annex - 3SL only)
2XM Charter™	30"	48"	AA Satin Aluminum	4 4 Wheel	WB TruBrite™ Whiteboard (Both Sides)	FRO Frosted Acrylic
3SL Annex™	37"	54"	BK Black	F Freestanding	WBF1_ TruBrite™ (Side 1)/ Fabric 1_ (Side 2)	WB TruBrite™ Whiteboard (Both Sides)
	42"	62"			WBF2_ TruBrite™ (Side 1)/ Fabric 2_ (Side 2)	F1_ Fabric 100 Series
	49"	72"				F2_ Fabric 200 Series
	61"					WBF1_ TruBrite™ (Side 1)/ Fabric 1_ (Side 2)
	73"					WBF2_ TruBrite™ (Side 1)/ Fabric 2_ (Side 2)
						P1_ EchoScape™ 3/8" (9mm)
						L1_ Laminates & Wood Grains 100 Series

TRUBRITE™ WHITEBOARDS - CHARTER™

Width	Height	Weight (lbs)	WB	FOOT OPTIONS
			TruBrite™ Whiteboard List Price	4 Wheel or Freestanding
30"	48"	19	\$753	+\$218
30"	54"	20	\$791	+\$218
30"	62"	23	\$1,211	+\$218
30"	72"	25	\$1,271	+\$218
37"	48"	21	\$878	+\$218
37"	54"	23	\$911	+\$218
37"	62"	26	\$1,265	+\$218
37"	72"	29	\$1,325	+\$218
42"	48"	23	\$950	+\$218
42"	54"	25	\$982	+\$218
42"	62"	28	\$1,298	+\$218
42"	72"	31	\$1,369	+\$218
49"	48"	25	\$999	+\$218
49"	54"	28	\$1,037	+\$218
49"	62"	31	\$1,358	+\$218
49"	72"	35	\$1,424	+\$218



CHARTER™
(Model 2XM)
Full Panel Dual-Sided Dry Erase Board

Accessories Available for Charter™ Model (Sold Separately)	SKU	Price
--	-----	-------

Flip Chart Clip Set
(quantity 2)



FCC \$30

NOTE:

All pricing in USD

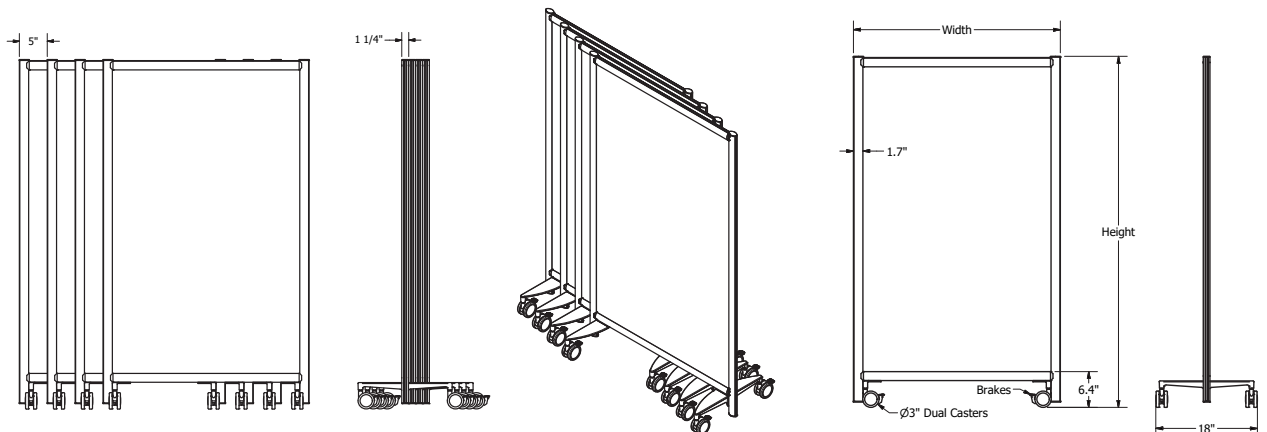

ANNEX™
(Model 3SL)
Dual-Sided Dry Erase
Whiteboard and
Lower Customized Panel with
Slatwall Accessory Rail



UPPER CORE - TRUBRITE™ (BOTH SIDES)											
LOWER CORES											FOOT OPTIONS
Width	Height	Weight (lbs)	FRO	WB	F1_	F2_	WBF1_	WBF2_	P1_	L1_	
			Frosted Acrylic	TruBrite™ Whiteboard	Fabric 100 Series	Fabric 200 Series	WB/Fabric 100 Series	WB/Fabric 200 Series	EchoScape™ 3/8" (9mm)	Laminate 100 Series	4 Wheel or Freestanding
37"	54"	26	\$1,058	\$1,053	\$1,098	\$1,129	\$1,098	\$1,129	\$1,009	\$1,140	+\$218
37"	62"	28	\$1,173	\$1,168	\$1,213	\$1,244	\$1,213	\$1,244	\$1,124	\$1,255	+\$218
37"	72"	31	\$1,238	\$1,233	\$1,278	\$1,309	\$1,278	\$1,309	\$1,189	\$1,320	+\$218
49"	54"	32	\$1,190	\$1,173	\$1,237	\$1,280	\$1,237	\$1,280	\$1,124	\$1,293	+\$218
49"	62"	35	\$1,353	\$1,336	\$1,400	\$1,443	\$1,400	\$1,443	\$1,287	\$1,456	+\$218
49"	72"	39	\$1,430	\$1,413	\$1,477	\$1,520	\$1,477	\$1,520	\$1,364	\$1,533	+\$218
61"	54"	37	\$1,719	\$1,724	\$1,742	\$1,801	\$1,742	\$1,801	\$1,643	\$1,812	+\$218
61"	62"	41	\$1,773	\$1,778	\$1,796	\$1,855	\$1,796	\$1,855	\$1,697	\$1,866	+\$218
61"	72"	46	\$1,849	\$1,854	\$1,872	\$1,931	\$1,872	\$1,931	\$1,773	\$1,942	+\$218
73"	54"	44	\$1,827	\$1,827	\$1,910	\$1,979	\$1,910	\$1,979	\$1,746	\$2,018	+\$218
73"	62"	49	\$1,887	\$1,887	\$1,970	\$2,039	\$1,970	\$2,039	\$1,806	\$2,078	+\$218
73"	72"	54	\$1,969	\$1,969	\$2,052	\$2,121	\$2,052	\$2,121	\$1,888	\$2,160	+\$218

UPPER CORE - TRUBRITE™ (SIDE 1) / FABRIC 1_ (SIDE 2)											
LOWER CORES											FOOT OPTIONS
Width	Height	Weight (lbs)	FRO	WB	F1_	F2_	WBF1_	WBF2_	P1_	L1_	
			Frosted Acrylic	TruBrite™ Whiteboard	Fabric 100 Series	Fabric 200 Series	WB/Fabric 100 Series	WB/Fabric 200 Series	EchoScape™ 3/8" (9mm)	Laminate 100 Series	4 Wheel or Freestanding
37"	54"	26	\$1,153	\$1,148	\$1,219	\$1,250	\$1,219	\$1,250	\$1,104	\$1,235	+\$218
37"	62"	28	\$1,281	\$1,276	\$1,354	\$1,385	\$1,354	\$1,385	\$1,232	\$1,363	+\$218
37"	72"	31	\$1,352	\$1,347	\$1,425	\$1,456	\$1,425	\$1,456	\$1,303	\$1,434	+\$218
49"	54"	32	\$1,295	\$1,278	\$1,369	\$1,412	\$1,369	\$1,412	\$1,229	\$1,398	+\$218
49"	62"	35	\$1,471	\$1,454	\$1,555	\$1,598	\$1,555	\$1,598	\$1,405	\$1,574	+\$218
49"	72"	39	\$1,574	\$1,557	\$1,661	\$1,704	\$1,661	\$1,704	\$1,508	\$1,677	+\$218
61"	54"	37	\$1,862	\$1,867	\$1,944	\$2,003	\$1,944	\$2,003	\$1,786	\$1,955	+\$218
61"	62"	41	\$1,926	\$1,931	\$2,008	\$2,067	\$2,008	\$2,067	\$1,850	\$2,019	+\$218
61"	72"	46	\$2,013	\$2,018	\$2,096	\$2,155	\$2,096	\$2,155	\$1,937	\$2,106	+\$218
73"	54"	44	\$2,007	\$2,007	\$2,152	\$2,221	\$2,152	\$2,221	\$1,926	\$2,198	+\$218
73"	62"	49	\$2,077	\$2,077	\$2,222	\$2,291	\$2,222	\$2,291	\$1,996	\$2,268	+\$218
73"	72"	54	\$2,175	\$2,175	\$2,322	\$2,391	\$2,322	\$2,391	\$2,094	\$2,366	+\$218

			UPPER CORE - TRUBRITE™ (SIDE 1) / FABRIC 2_ (SIDE 2)								FOOT OPTIONS
			LOWER CORES								
Width	Height	Weight (lbs)	FRO	WB	F1_	F2_	WBF1_	WBF2_	P1_	L1_	
			Frosted Acrylic	TruBrite™ Whiteboard	Fabric 100 Series	Fabric 200 Series	WB/Fabric 100 Series	WB/Fabric 200 Series	EchoScape™ 3/8" (9mm)	Laminate 100 Series	4 Wheel or Freestanding
37"	54"	26	\$1,216	\$1,211	\$1,280	\$1,311	\$1,280	\$1,311	\$1,167	\$1,298	+\$218
37"	62"	28	\$1,334	\$1,329	\$1,402	\$1,433	\$1,402	\$1,433	\$1,285	\$1,416	+\$218
37"	72"	31	\$1,405	\$1,400	\$1,473	\$1,504	\$1,473	\$1,504	\$1,356	\$1,487	+\$218
49"	54"	32	\$1,407	\$1,390	\$1,481	\$1,524	\$1,481	\$1,524	\$1,341	\$1,510	+\$218
49"	62"	35	\$1,567	\$1,550	\$1,648	\$1,691	\$1,648	\$1,691	\$1,501	\$1,670	+\$218
49"	72"	39	\$1,648	\$1,631	\$1,729	\$1,772	\$1,729	\$1,772	\$1,582	\$1,751	+\$218
61"	54"	37	\$1,946	\$1,951	\$2,018	\$2,077	\$2,018	\$2,077	\$1,870	\$2,039	+\$218
61"	62"	41	\$2,011	\$2,016	\$2,084	\$2,143	\$2,084	\$2,143	\$1,935	\$2,104	+\$218
61"	72"	46	\$2,103	\$2,108	\$2,177	\$2,236	\$2,177	\$2,236	\$2,027	\$2,196	+\$218
73"	54"	44	\$2,107	\$2,107	\$2,242	\$2,311	\$2,242	\$2,311	\$2,026	\$2,298	+\$218
73"	62"	49	\$2,183	\$2,183	\$2,319	\$2,388	\$2,319	\$2,388	\$2,102	\$2,374	+\$218
73"	72"	54	\$2,286	\$2,286	\$2,424	\$2,493	\$2,424	\$2,493	\$2,205	\$2,477	+\$218

Accessories Available for Annex Model (Sold Separately)	SKU	Price
 <p>Flip Chart Clip Set (quantity 2)</p>	FCC	\$30
 <p>Pen Cup - Rail Series</p>	S-PC	\$33
 <p>Marker Tray - Rail Series</p>	S-WBTR	\$77

NOTE:
All pricing in USD
Uses Slatwall Accessories

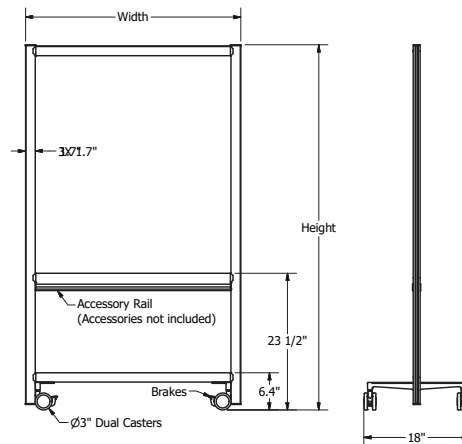

MATERIAL OPTIONS

ECHOSCAPE™ 3/8" (9MM)

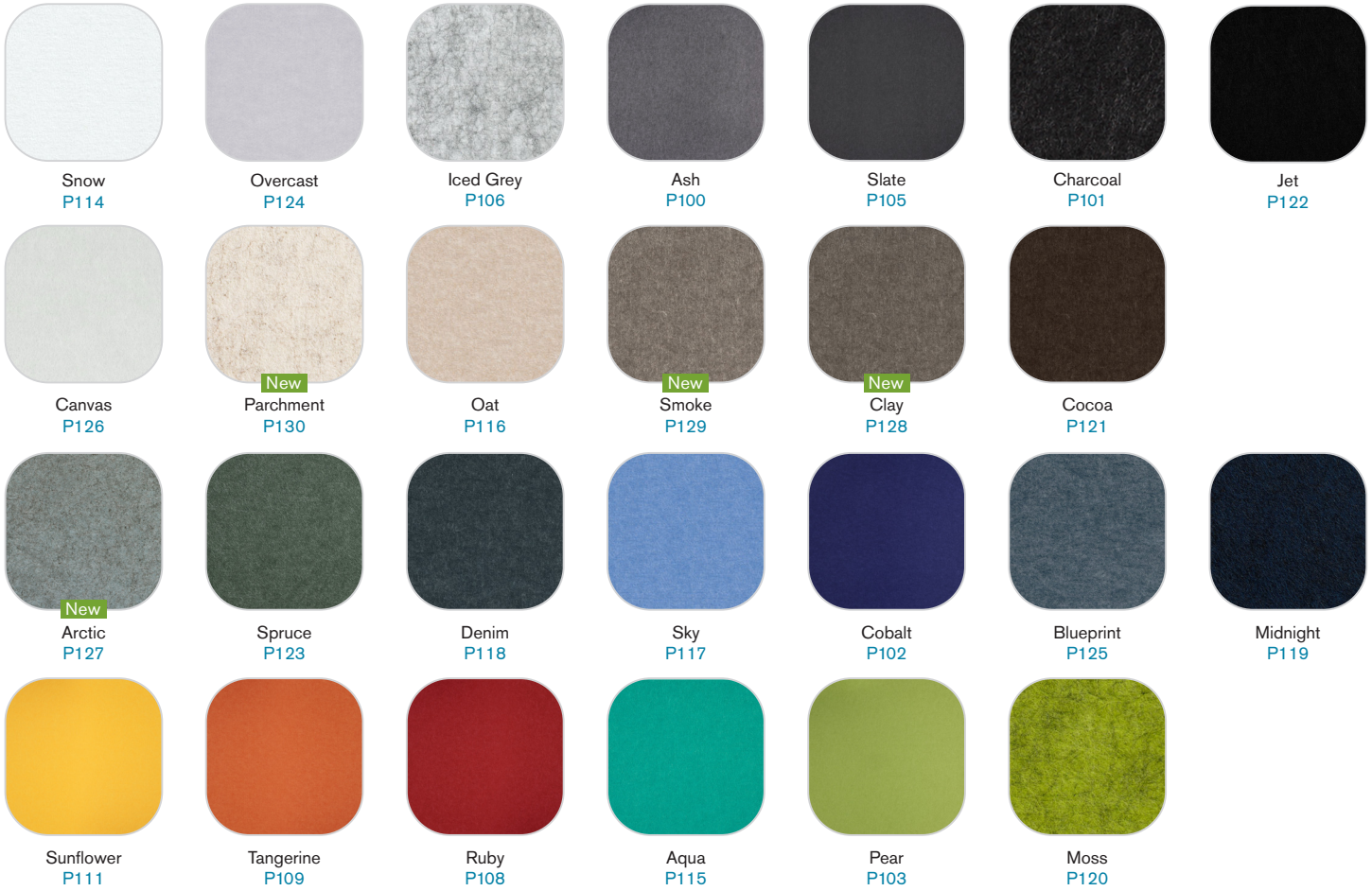

FABRICS 200 SERIES

FELTRO | NEW NOVEMBER 2023

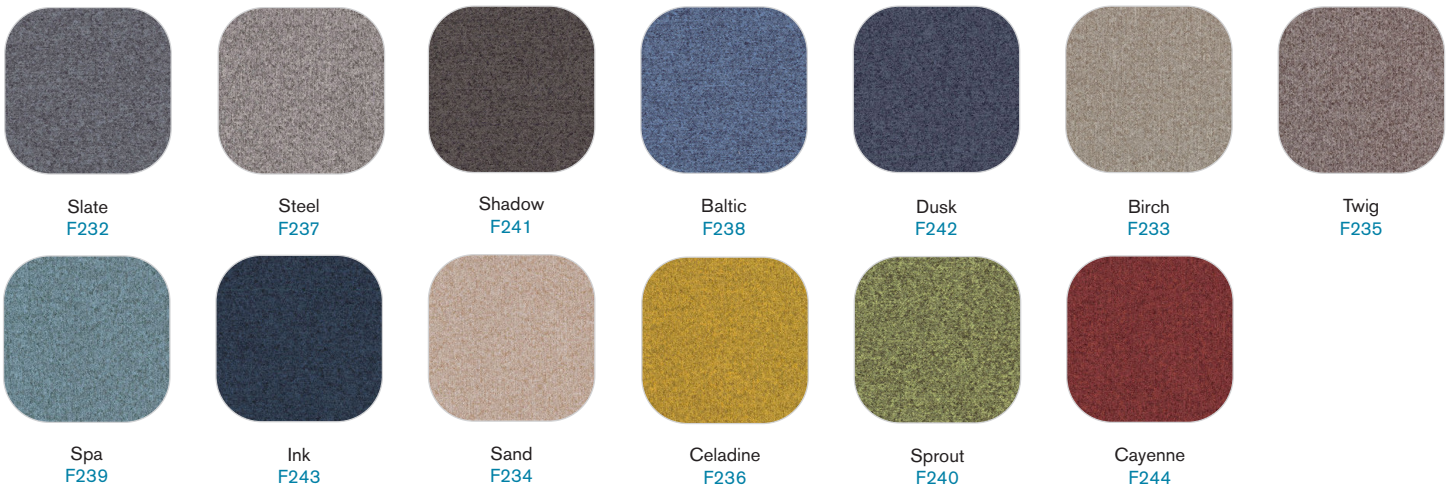

DEKA | NEW NOVEMBER 2023



Moon
F245

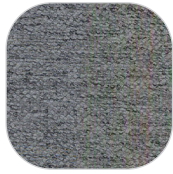

Mercury
F252



Pewter
F256



Refresh
F247



Rain
F249

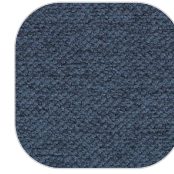

Nordic
F253



Charcoal
F257



Peridot
F250



Copper
F254



Bisque
F251



Driftwood
F255



Pumice
F246



Sage
F248

INFINITY



Dove
F223



Barley
F210



Stucco
F221



Aluminum
F222



Gull
F230

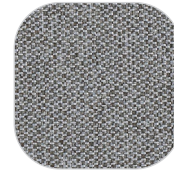

Pewter
F231

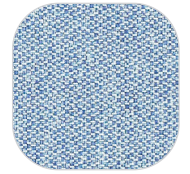

Aster
F219

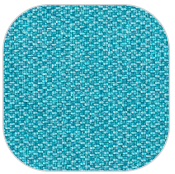

Rinse
F214

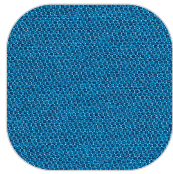

Capri
F218

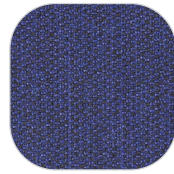

Beyond
F220

FABRICS 100 SERIES

ORIGIN

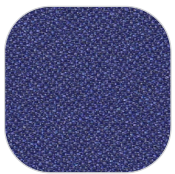

Euro
F102

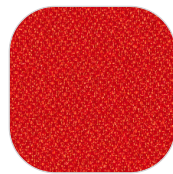

Poppy
F104

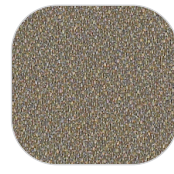

Arundel
F112



Stately
F113



Basalt
F122



Jet
F123



Iron
F121



Steel
F120



Sapphire
F114



Sodalite
F108

LAMINATES

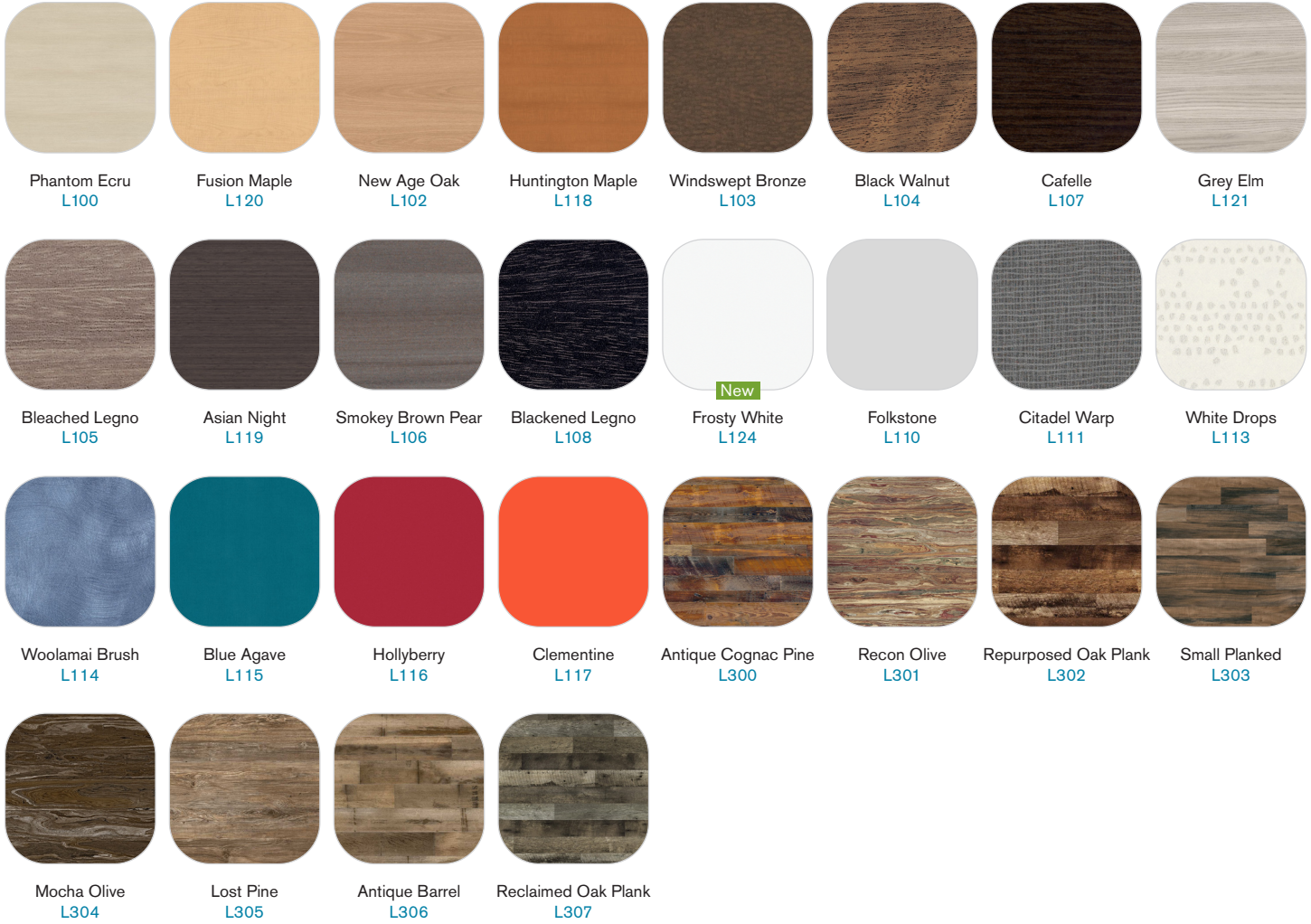

FROSTED ACRYLIC



Frosted Acrylic
FRO

FRAMES

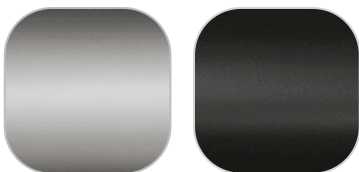

Satin Aluminum
AA

Black
BK