

ECHOWRAP™ U-PANEL

Price Effective - January 1, 2021



VISUAL AND ACOUSTIC PRIVACY AND PROTECTION

Take back your space with EchoWrap™ desk panels. EchoWrap desk panels surround your desk to keep out unwanted noise so you can focus on what's important. Using our highly rated acoustic and sustainable EchoScape™ material, EchoWrap™ panels absorb noise from both the front and back of the panels.

Designed with a living hinge to follow the shape of your desk or table, our acoustic U-EchoWrap surrounds 3 sides of your workspace to create a private yet collaborative workspace. Versatile EchoWrap panels are available with permanent or removable mount options to fit any table or desk.



- One panel mounts on back edge of worksurface and wraps around 2 sides
- Permanent or removable mounting assembly available
- Wing depth is measured from bottom of panel
- Wing sides are finished with 10° taper
- Multiple width and height options available
- Set height removable or permanent mount brackets available
- Acoustic EchoScape 3/4" (18mm) - 0.9 NRC rated
- Available in 8 colors
- EchoScape material can be cleaned with disinfectant sprays and fabric or carpet cleaners

How to build your SKU:

Step 1: Choose your Model	Step 2: Choose your Width & Depth	Step 3: Choose your Overall Height	Step 4: Choose your Fixed Height above work surface *	Step 5: Choose your Material Color	Step 6: Banner Cutout Design (optional)	Step 7: Choose your Mounting Option
EWU	4820	24	18	P101	D021	SP

ECHOWRAP™ U-PANEL

Model	Width & Depth	Overall Height	Fixed Height above work surface *	Material Color	Banner Cutout Designs (optional)	Mounting
EWU U-EchoWrap™	48"w (Back) x 20"d (2-Wings)	24"	12"	P100 Ash EchoScape™ 3/4" (18mm)	D002 Fizzy	SP Permanent Mount (silver)
	54"w (Back) x 20"d (2-Wings)	30"	18"	P101 Charcoal EchoScape™ 3/4" (18mm)	D004 Metro	SC Removable Mount (silver)
	60"w (Back) x 17"d (2-Wings)		24"	P102 Cobalt EchoScape™ 3/4" (18mm)	D005 Dash	BP Permanent Mount (black)
	66"w (Back) x 14"d (2-Wings)			P103 Pear EchoScape™ 3/4" (18mm)	D008 Tribal	BC Removable Mount (black)
	72"w (Back) x 11"d (2-Wings)			P104 Sandstone EchoScape™ 3/4" (18mm)	D016 Retro	
				P105 Slate EchoScape™ 3/4" (18mm)	D017 Strata	
				P106 Iced Grey EchoScape™ 3/4" (18mm)	D021 Maze	
			P107 Linen EchoScape™ 3/4" (18mm)	D022 Aztec		
				D023 Pinwheel		

*Above work surface heights based on 1.25" work surface

ECHOWRAP™ U-PANEL - INSTALLATION OPTIONS

OPTION 1



24" Overall Panel Height

12" Fixed height above 1.25" worksurface

30" Overall Panel Height

18" Fixed height above 1.25" worksurface

12" Fixed height below 1.25" worksurface

OPTION 2



24" Overall Panel Height

18" Fixed height above 1.25" worksurface

30" Overall Panel Height

24" Fixed height above 1.25" worksurface

6" Fixed height below 1.25" worksurface

MOUNTING OPTIONS



SP
Permanent Mount



BP
Permanent Mount

- Permanently mounts to bottom of work surface
- Works on all thickness table tops
- Faceplates and Mount available in Silver or Black



SC
Removable Mount



BC
Removable Mount

- Mounts along edge of work surface
- Clamp fits 3/4" to 2" thick tops
- Faceplates and Mount available in Silver or Black

ECHOWRAP™ U-PANEL

See pages 4-5 for Banner Design Cutout Options

EWU-PE18

Width of Back Panel	Depth of 2 Wing Sides	Overall Height of Panel	Fixed Height ABOVE Work Surface	Fixed Height BELOW Work Surface	Panel & Mount Price (Permanent or Removeable)	Banner Design Cutout (optional)	Qty of Clamps for Back Panel Section	Qty of Clamps for Wing Panel Section (1 Mount per Wing)
48"	20"	24"	18"	6"	\$700	+\$80	2	2
48"	20"	24"	12"	12"	\$700	+\$80	2	2
48"	20"	30"	24"	6"	\$725	+\$80	2	2
48"	20"	30"	18"	12"	\$725	+\$80	2	2
54"	20"	24"	18"	6"	\$710	+\$80	2	2
54"	20"	24"	12"	12"	\$710	+\$80	2	2
54"	20"	30"	24"	6"	\$735	+\$80	2	2
54"	20"	30"	18"	12"	\$735	+\$80	2	2
60"	17"	24"	18"	6"	\$760	+\$90	4	2
60"	17"	24"	12"	12"	\$760	+\$90	4	2
60"	17"	30"	24"	6"	\$785	+\$90	4	2
60"	17"	30"	18"	12"	\$785	+\$90	4	2
66"	14"	24"	18"	6"	\$760	+\$90	4	2
66"	14"	24"	12"	12"	\$760	+\$90	4	2
66"	14"	30"	24"	6"	\$785	+\$90	4	2
66"	14"	30"	18"	12"	\$785	+\$90	4	2
72"	11"	24"	18"	6"	\$760	+\$100	4	2
72"	11"	24"	12"	12"	\$760	+\$100	4	2
72"	11"	30"	24"	6"	\$785	+\$100	4	2
72"	11"	30"	18"	12"	\$785	+\$100	4	2

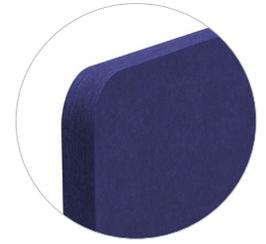

ECHOWRAP™ U-PANEL EchoScape™ 3/4" (18mm) (PE18)

NOTE:

All pricing in USD

Sound Absorbent - EchoScape™ 3/4" (18mm) is rated at .9 NRC

Eco-Friendly - EchoScape™ is made from 60% post-consumer reclaimed plastic water bottles, is VOC-free, and 100% recyclable

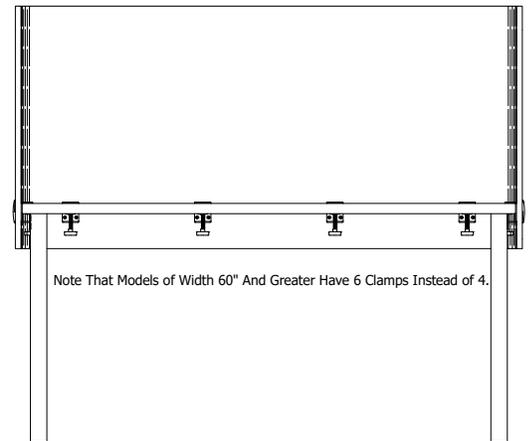
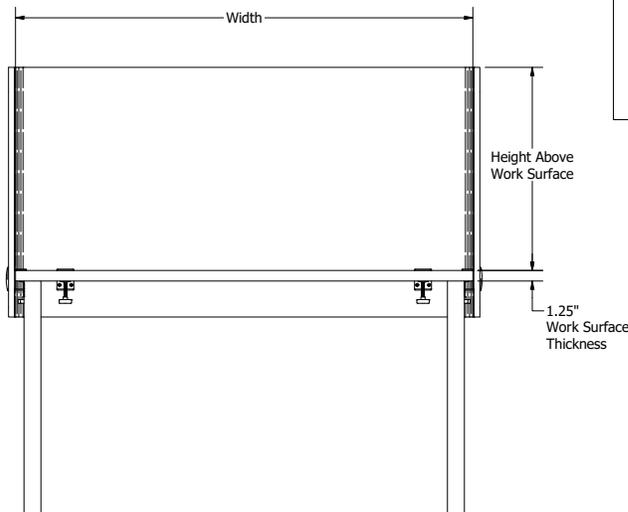
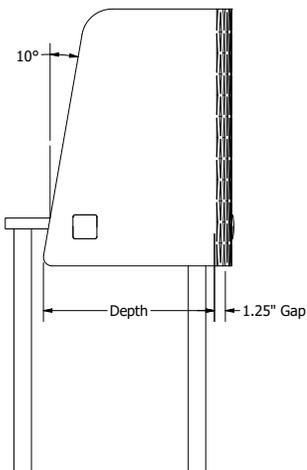

DESIGN CUTOUTS

EchoScape™ (PE18)

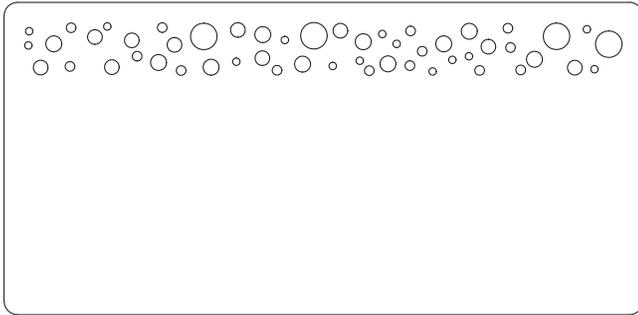

D002 - FIZZY

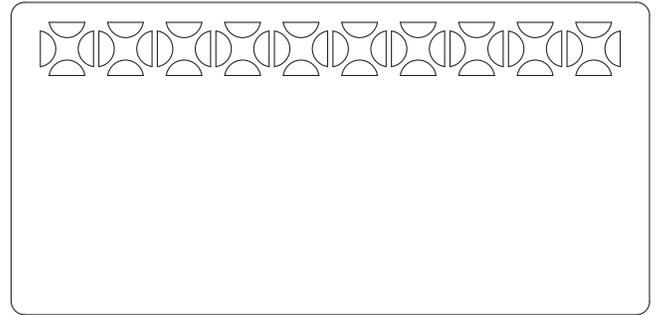

D004 - METRO

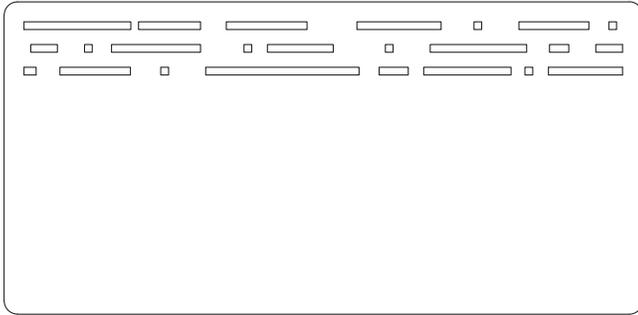

D005 - DASH

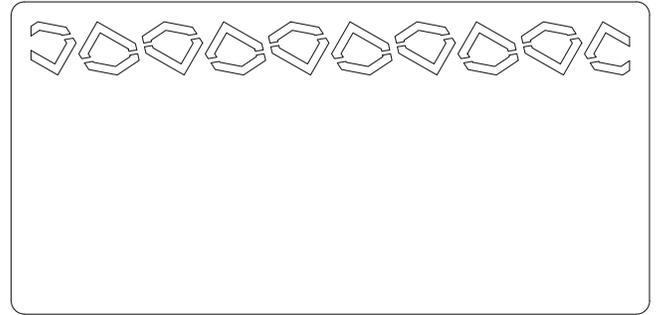

D008 - TRIBAL

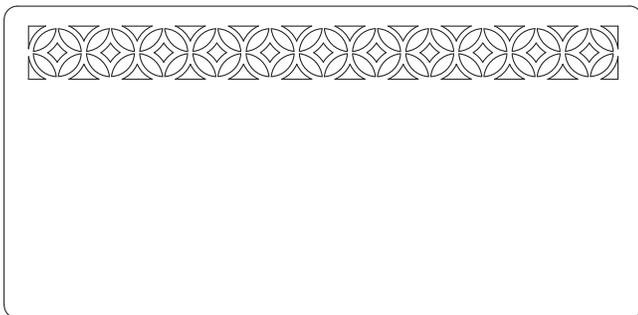

D016 - RETRO

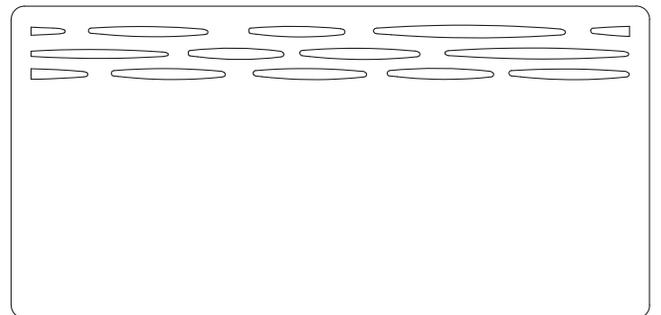

D017 - STRATA

DESIGN CUTOUTS

EchoScape™ (PE18)

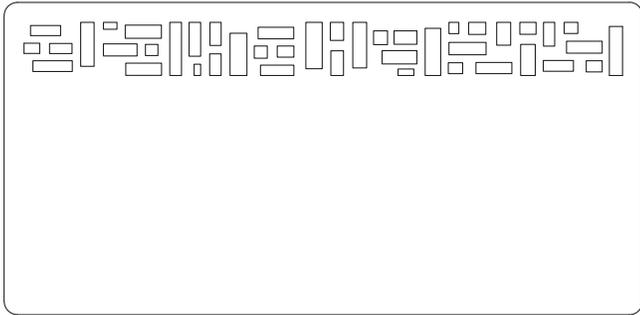

D021 - MAZE

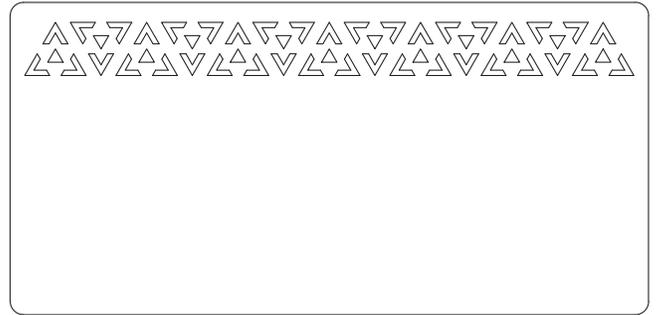

D022 - AZTEC

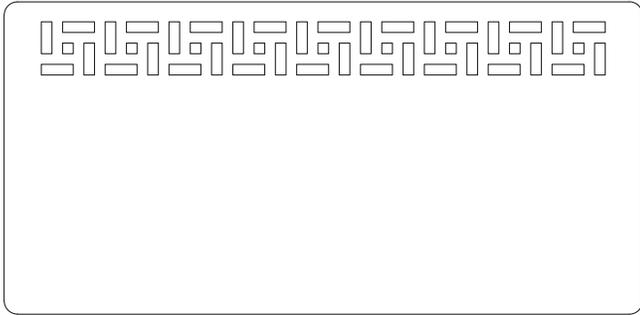

D023 - PINWHEEL

ECHOSCAPE™ 3/4" (18MM) (P1_)



Ash
P100



Charcoal
P101



Cobalt
P102



Pear
P103



Sandstone
P104



Slate
P105



Iced Grey
P106



Linen
P107