

ENCLAVE™ PANEL

ABOVE THE DESK DIVIDERS



Enclave™ desk dividers are the perfect solution for both visual and sound privacy. Available in a wide range of styles, colors, materials and acoustic properties, our panels are designed to merge with any work surface. With a simple installation process and a variety of permanent and removeable mounting options, you can turn existing desks and tables into personalized workstations that help maintain productivity and tune out distractions.

- Desk dividers available in several materials and colors including Frosted Acrylic, Fabric, TruBrite™ Whiteboard and EchoScape™
- Tackable fabric panels are finished with 3 different trim options: Fabric Fold, Edge Band and Metal Trim
- EchoScape™ 3/4" (18mm), our 0.9 NRC rated acoustic solution, effectively controls noise disruptions by absorbing sound
- Permanent and removeable mounting options available
- Made in the USA
- Customization available – special materials, sizes, shapes and mounting options



FROSTED ACRYLIC
(Style FRO)



COLORED FROSTED ACRYLIC
(Style CFRO)



TRUBRITE™ WHITEBOARD
(Style WB)



FABRIC FOLD
(Style FF)

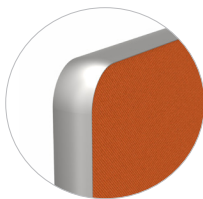

EDGE BAND
(Style EB2)

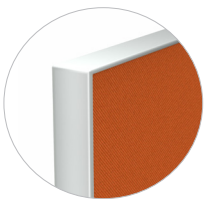

METAL TRIM
(Style MT2)

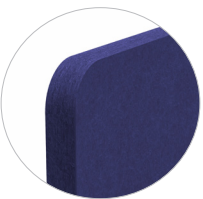

ECHOSCAPE™
(Style PE18)

How to build your SKU:

Step 1:
Choose your Model

FAD

Step 2:
Choose your Style

EB

Step 3:
Choose your Width

23

Step 3:
Choose your Height

12

Step 4:
Choose your Material Color

F118

Step 5:
Choose your Edge Band Color

BK

(EB Style only)

Step 6:
Choose your Mounting Option

VCEH2

ENCLAVE™ PANEL

Model	Style	Width	Height	Material Color	Edge Band (EB Style only)	Mounting
FAD Enclave™ Panel	FRO Frosted Acrylic	17"	12"	A1_ Colored Frosted Acrylic	SV Silver	TM Top Mount
	CFRO Colored Frosted Acrylic	23"	16"	F1_ Fabric Series 100	BK Black	CEL Edge Clamp - Lever
	WB TruBrite™ Whiteboard	29"	18"	F2_ Fabric Series 200	WT White	CEH Edge Clamp - Hex
	FF Fabric Fold	36"	24"	P1_ EchoScape™		CEK Edge Clamp - Knob
	EB2 Edge Band	42"				CMS Middle Clamp
	MT2 Metal Trim	48"				CMD Middle Clamp - Double
	PE18 EchoScape™	54"				CMKS Middle Clamp - Knob
		60"				FS Free Standing
		66"				BM Bench Mount
		72"				



V-Mount

Adjustable opening accommodates Frosted Acrylic, Fabric Fold, EchoScape™ and TruBrite™ Whiteboard divider panels

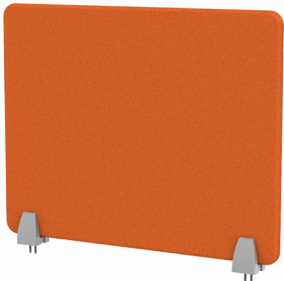

Top Mount (TM)

- Use for permanent mounting
- Locate anywhere on the desk
- Work on all thickness tops
- Clamp position on panel is adjustable
- Kits include 2 or 3 Top Mounts depending on the width of the desk divider

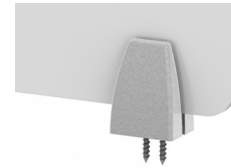

Top Mount (VTM)

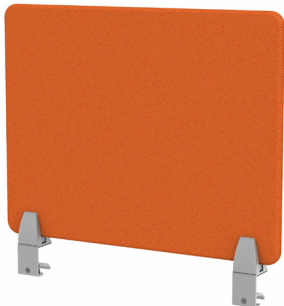

Edge Clamp - Lever (CEL)

- Patented Lever allows for easy installation with no low hanging knob
- Fast & easy installation and relocation
- Mount along the edge of work surface
- Clamp fits 5/8" to 2" thick tops
- No screwing or drilling into work surface required
- Clamp position on panel is adjustable
- Kits include 2 or 3 Clamps depending on the width of the desk divider

*Patented



Edge Clamp - Lever (VCEL)

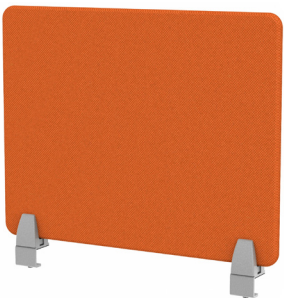

Edge Clamp - Hex (CEH) (Low Profile)

- Fast & easy installation and relocation
- Mount along the edge of work surface
- Clamp fits 1.1" to 1.22" thick tops
- No screwing or drilling into work surface required
- Clamp position on panel is adjustable
- Kits include 2 or 3 Clamps depending on the width of the desk divider
- Use when minimum free space is available on underside of work surface



Edge Clamp - Hex (VCEH)

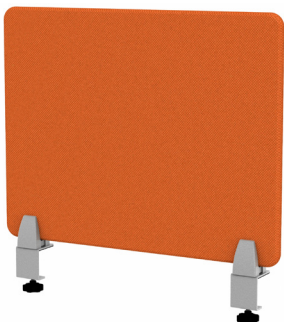

Edge Clamp - Knob (CEK)

- Fast & easy installation and relocation
- Mount along the edge of work surface
- Clamp fits 3/4" to 2" thick tops
- No screwing or drilling into work surface required
- Clamp position on panel is adjustable
- Kits include 2 or 3 Clamps depending on the width of the desk divider



Edge Clamp - Knob (VCEK)



Middle Clamp - Single (CMS)

- Patented Lever allows for easy installation with no low hanging knob
 - Fast & easy installation and relocation
 - Mount perpendicular to edge of work surface
 - Clamp fits 5/8" to 2" thick tops
 - No screwing or drilling into work surface required
 - Only one clamp required to secure a desk divider
- *Patented*



Middle Clamp - Single (VCMS)

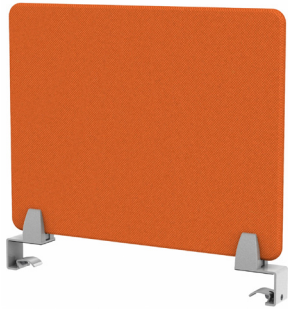

Middle Clamp - Double (CMD)

- Patented Lever allows for easy installation with no low hanging knob
 - Fast & easy installation and relocation
 - Mount perpendicular to edge of work surface
 - Clamp fits 5/8" to 2" thick tops
 - No screwing or drilling into work surface required
 - Two clamps for use with larger dividers
 - A center Pad will be included on units 54" and wider
- *Patented*



Middle Clamp - Double (VCMD)



Middle Clamp - Knob (CMKS)

- Fast & easy installation and relocation
- Mount perpendicular to edge of work surface
- Clamp fits 1.1" to 1.22" thick tops
- No screwing or drilling into work surface
- Only one clamp required to secure panel to work surface
- Kit includes 1 middle clamp with knob and one or two metal resting plates depending on width of panel



Middle Clamp - Knob (VCMKS)

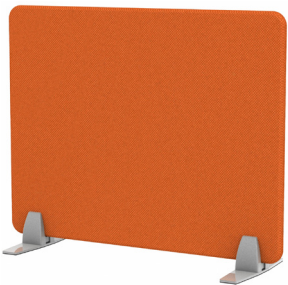

Free Standing Foot (FS)

- Fast & easy installation and relocation
- Stands freely on top of work surface
- Clamp position on panel is adjustable
- No screwing or drilling into work surface required
- A center Pad will be included on units 54" and wider

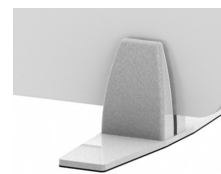

Free Standing (VFS)



Bench Mount (BM)

- Use for permanent mounting
- Fits between back to back workstations with a minimum gap of 2.25"
- Clamp position on panel is adjustable
- Can be used on all thickness tops
- Kit includes 2 to 3 Bench Mounts depending on width of the panel



Bench Mount (VBM)

ENCLAVE™ PANEL - FROSTED ACRYLIC

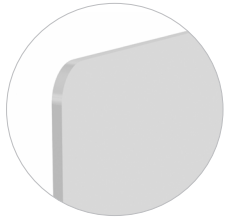

ENCLAVE™ PANEL
Style - Frosted Acrylic (FRO)

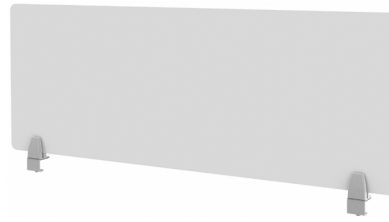

Shown with Edge
Clamp - Hex (VCEH2)

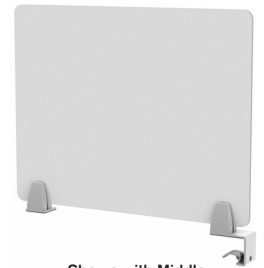

Shown with Middle
Clamp - Single (VCMS)

MOUNTING OPTIONS

FAD-FRO				Top Mount	Price	Edge Clamp Lever	Edge Clamp Hex	Edge Clamp Knob	Middle Clamp	Middle Clamp Double	Middle Clamp Knob	Free Standing	Bench Mount	Price
Width	Height	Weight (lbs)	Base Price											
17" *	12"	4	\$90	VTM2	+\$38	VCEL2	VCEH2	VCEK2	VCMS	VCMD	VCMKS	VFS2	VBM2	+\$66
17" *	16"	5	\$110	VTM2	+\$38	VCEL2	VCEH2	VCEK2	VCMS	VCMD	VCMKS	VFS2	VBM2	+\$66
17" *	18"	5	\$120	VTM2	+\$38	VCEL2	VCEH2	VCEK2	VCMS	VCMD	VCMKS	VFS2	VBM2	+\$66
17" *	24"	6	\$140	VTM2	+\$38	VCEL2	VCEH2	VCEK2	VCMS	VCMD	VCMKS	VFS2	VBM2	+\$66
23" *	12"	5	\$110	VTM2	+\$38	VCEL2	VCEH2	VCEK2	VCMS	VCMD	VCMKS	VFS2	VBM2	+\$66
23" *	16"	5	\$125	VTM2	+\$38	VCEL2	VCEH2	VCEK2	VCMS	VCMD	VCMKS	VFS2	VBM2	+\$66
23" *	18"	6	\$140	VTM2	+\$38	VCEL2	VCEH2	VCEK2	VCMS	VCMD	VCMKS	VFS2	VBM2	+\$66
23" *	24"	7	\$175	VTM2	+\$38	VCEL2	VCEH2	VCEK2	VCMS	VCMD	VCMKS	VFS2	VBM2	+\$66
29" *	12"	5	\$125	VTM2	+\$38	VCEL2	VCEH2	VCEK2	VCMS	VCMD	VCMKS	VFS2	VBM2	+\$66
29" *	16"	6	\$145	VTM2	+\$38	VCEL2	VCEH2	VCEK2	VCMS	VCMD	VCMKS	VFS2	VBM2	+\$66
29" *	18"	7	\$170	VTM2	+\$38	VCEL2	VCEH2	VCEK2	VCMS	VCMD	VCMKS	VFS2	VBM2	+\$66
29" *	24"	8	\$210	VTM2	+\$38	VCEL2	VCEH2	VCEK2	VCMS	VCMD	VCMKS	VFS2	VBM2	+\$66
36"	12"	6	\$145	VTM2	+\$38	VCEL2	VCEH2	VCEK2	N/A	VCMD	N/A	VFS2	VBM2	+\$66
36"	16"	7	\$180	VTM2	+\$38	VCEL2	VCEH2	VCEK2	N/A	VCMD	N/A	VFS2	VBM2	+\$66
36"	18"	8	\$205	VTM2	+\$38	VCEL2	VCEH2	VCEK2	N/A	VCMD	N/A	VFS2	VBM2	+\$66
36"	24"	10	\$245	VTM2	+\$38	VCEL2	VCEH2	VCEK2	N/A	VCMD	N/A	VFS2	VBM2	+\$66
42"	12"	7	\$170	VTM2	+\$38	VCEL2	VCEH2	VCEK2	N/A	VCMD	N/A	VFS2	VBM2	+\$66
42"	16"	8	\$210	VTM2	+\$38	VCEL2	VCEH2	VCEK2	N/A	VCMD	N/A	VFS2	VBM2	+\$66
42"	18"	9	\$240	VTM2	+\$38	VCEL2	VCEH2	VCEK2	N/A	VCMD	N/A	VFS2	VBM2	+\$66
42"	24"	11	\$320	VTM2	+\$38	VCEL2	VCEH2	VCEK2	N/A	VCMD	N/A	VFS2	VBM2	+\$66
48"	12"	7	\$190	VTM2	+\$38	VCEL2	VCEH2	VCEK2	N/A	VCMD	N/A	VFS2	VBM2	+\$66
48"	16"	9	\$225	VTM2	+\$38	VCEL2	VCEH2	VCEK2	N/A	VCMD	N/A	VFS2	VBM2	+\$66
48"	18"	10	\$265	VTM2	+\$38	VCEL2	VCEH2	VCEK2	N/A	VCMD	N/A	VFS2	VBM2	+\$66
48"	24"	12	\$325	VTM2	+\$38	VCEL2	VCEH2	VCEK2	N/A	VCMD	N/A	VFS2	VBM2	+\$66
54"	12"	8	\$195	VTM2	+\$38	VCEL2	VCEH2	VCEK2	N/A	VCMD	N/A	VFS2	VBM2	+\$66
54"	16"	10	\$250	VTM2	+\$38	VCEL2	VCEH2	VCEK2	N/A	VCMD	N/A	VFS2	VBM2	+\$66
54"	18"	11	\$290	VTM2	+\$38	VCEL2	VCEH2	VCEK2	N/A	VCMD	N/A	VFS2	VBM2	+\$66
54"	24"	14	\$335	VTM2	+\$38	VCEL2	VCEH2	VCEK2	N/A	VCMD	N/A	VFS2	VBM2	+\$66
60"	12"	8	\$230	VTM3	+\$57	VCEL3	VCEH3	VCEK3	N/A	VCMDP	N/A	VFS2P	VBM3	+\$99
60"	16"	11	\$295	VTM3	+\$57	VCEL3	VCEH3	VCEK3	N/A	VCMDP	N/A	VFS2P	VBM3	+\$99
60"	18"	12	\$325	VTM3	+\$57	VCEL3	VCEH3	VCEK3	N/A	VCMDP	N/A	VFS2P	VBM3	+\$99
60"	24"	15	\$430	VTM3	+\$57	VCEL3	VCEH3	VCEK3	N/A	VCMDP	N/A	VFS2P	VBM3	+\$99
66"	12"	9	\$235	VTM3	+\$57	VCEL3	VCEH3	VCEK3	N/A	VCMDP	N/A	VFS2P	VBM3	+\$99
66"	16"	11	\$300	VTM3	+\$57	VCEL3	VCEH3	VCEK3	N/A	VCMDP	N/A	VFS2P	VBM3	+\$99
66"	18"	13	\$330	VTM3	+\$57	VCEL3	VCEH3	VCEK3	N/A	VCMDP	N/A	VFS2P	VBM3	+\$99
66"	24"	16	\$435	VTM3	+\$57	VCEL3	VCEH3	VCEK3	N/A	VCMDP	N/A	VFS2P	VBM3	+\$99
72"	12"	10	\$255	VTM3	+\$57	VCEL3	VCEH3	VCEK3	N/A	VCMDP	N/A	VFS2P	VBM3	+\$99
72"	16"	12	\$305	VTM3	+\$57	VCEL3	VCEH3	VCEK3	N/A	VCMDP	N/A	VFS2P	VBM3	+\$99
72"	18"	14	\$375	VTM3	+\$57	VCEL3	VCEH3	VCEK3	N/A	VCMDP	N/A	VFS2P	VBM3	+\$99
72"	24"	17	\$445	VTM3	+\$57	VCEL3	VCEH3	VCEK3	N/A	VCMDP	N/A	VFS2P	VBM3	+\$99

NOTE:

All pricing in USD

Quantity of mounting clamps noted as last number in SKU

Middle Clamp (VCMS) and Middle Clamp Knob (VCMKS) kits include 1 clamp and 1 metal stability plate

* Dimension is 1" less than width of desk to allow for rear panel (see page 13)

Middle Clamp Double (VCMD) includes 2 clamps

Middle Clamp Double with Pad (VCMDP) for panel widths 54" and larger, includes 2 clamps and 1 stability plate

ENCLAVE™ PANEL - COLORED FROSTED ACRYLIC



ENCLAVE™ PANEL
Style - Colored Frosted Acrylic (CFRO)



Shown with Top Mount (VTM2)

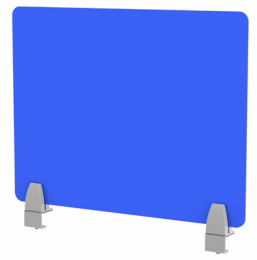

Shown with Edge Clamp - Hex (VCEH2)

MOUNTING OPTIONS

FAD-CFRO				MOUNTING OPTIONS										
Width	Height	Weight (lbs)	Base Price	Top Mount	Price	Edge Clamp Lever	Edge Clamp Hex	Edge Clamp Knob	Middle Clamp	Middle Clamp Double	Middle Clamp Knob	Free Standing	Bench Mount	Price
17" *	12"	4	\$125	VTM2	+\$38	VCEL2	VCEH2	VCEK2	VCMS	VCMD	VCMKS	VFS2	VBM2	+\$66
17" *	16"	5	\$165	VTM2	+\$38	VCEL2	VCEH2	VCEK2	VCMS	VCMD	VCMKS	VFS2	VBM2	+\$66
17" *	18"	5	\$215	VTM2	+\$38	VCEL2	VCEH2	VCEK2	VCMS	VCMD	VCMKS	VFS2	VBM2	+\$66
17" *	24"	6	\$225	VTM2	+\$38	VCEL2	VCEH2	VCEK2	VCMS	VCMD	VCMKS	VFS2	VBM2	+\$66
23" *	12"	5	\$155	VTM2	+\$38	VCEL2	VCEH2	VCEK2	VCMS	VCMD	VCMKS	VFS2	VBM2	+\$66
23" *	16"	5	\$195	VTM2	+\$38	VCEL2	VCEH2	VCEK2	VCMS	VCMD	VCMKS	VFS2	VBM2	+\$66
23" *	18"	6	\$225	VTM2	+\$38	VCEL2	VCEH2	VCEK2	VCMS	VCMD	VCMKS	VFS2	VBM2	+\$66
23" *	24"	7	\$270	VTM2	+\$38	VCEL2	VCEH2	VCEK2	VCMS	VCMD	VCMKS	VFS2	VBM2	+\$66
29" *	12"	5	\$195	VTM2	+\$38	VCEL2	VCEH2	VCEK2	VCMS	VCMD	VCMKS	VFS2	VBM2	+\$66
29" *	16"	6	\$245	VTM2	+\$38	VCEL2	VCEH2	VCEK2	VCMS	VCMD	VCMKS	VFS2	VBM2	+\$66
29" *	18"	7	\$270	VTM2	+\$38	VCEL2	VCEH2	VCEK2	VCMS	VCMD	VCMKS	VFS2	VBM2	+\$66
29" *	24"	8	\$345	VTM2	+\$38	VCEL2	VCEH2	VCEK2	VCMS	VCMD	VCMKS	VFS2	VBM2	+\$66
36"	12"	6	\$225	VTM2	+\$38	VCEL2	VCEH2	VCEK2	N/A	VCMD	N/A	VFS2	VBM2	+\$66
36"	16"	7	\$305	VTM2	+\$38	VCEL2	VCEH2	VCEK2	N/A	VCMD	N/A	VFS2	VBM2	+\$66
36"	18"	8	\$395	VTM2	+\$38	VCEL2	VCEH2	VCEK2	N/A	VCMD	N/A	VFS2	VBM2	+\$66
36"	24"	10	\$455	VTM2	+\$38	VCEL2	VCEH2	VCEK2	N/A	VCMD	N/A	VFS2	VBM2	+\$66
42"	12"	7	\$270	VTM2	+\$38	VCEL2	VCEH2	VCEK2	N/A	VCMD	N/A	VFS2	VBM2	+\$66
42"	16"	8	\$345	VTM2	+\$38	VCEL2	VCEH2	VCEK2	N/A	VCMD	N/A	VFS2	VBM2	+\$66
42"	18"	9	\$405	VTM2	+\$38	VCEL2	VCEH2	VCEK2	N/A	VCMD	N/A	VFS2	VBM2	+\$66
42"	24"	11	\$495	VTM2	+\$38	VCEL2	VCEH2	VCEK2	N/A	VCMD	N/A	VFS2	VBM2	+\$66
48"	12"	7	\$280	VTM2	+\$38	VCEL2	VCEH2	VCEK2	N/A	VCMD	N/A	VFS2	VBM2	+\$66
48"	16"	9	\$350	VTM2	+\$38	VCEL2	VCEH2	VCEK2	N/A	VCMD	N/A	VFS2	VBM2	+\$66
48"	18"	10	\$410	VTM2	+\$38	VCEL2	VCEH2	VCEK2	N/A	VCMD	N/A	VFS2	VBM2	+\$66
48"	24"	12	\$505	VTM2	+\$38	VCEL2	VCEH2	VCEK2	N/A	VCMD	N/A	VFS2	VBM2	+\$66
54"	12"	8	\$450	VTM2	+\$38	VCEL2	VCEH2	VCEK2	N/A	VCMD	N/A	VFS2	VBM2	+\$66
54"	16"	10	\$580	VTM2	+\$38	VCEL2	VCEH2	VCEK2	N/A	VCMD	N/A	VFS2	VBM2	+\$66
54"	18"	11	\$825	VTM2	+\$38	VCEL2	VCEH2	VCEK2	N/A	VCMD	N/A	VFS2	VBM2	+\$66
54"	24"	14	\$840	VTM2	+\$38	VCEL2	VCEH2	VCEK2	N/A	VCMD	N/A	VFS2	VBM2	+\$66
60"	12"	8	\$455	VTM3	+\$57	VCEL3	VCEH3	VCEK3	N/A	VCMDP	N/A	VFS2P	VBM3	+\$99
60"	16"	11	\$585	VTM3	+\$57	VCEL3	VCEH3	VCEK3	N/A	VCMDP	N/A	VFS2P	VBM3	+\$99
60"	18"	12	\$830	VTM3	+\$57	VCEL3	VCEH3	VCEK3	N/A	VCMDP	N/A	VFS2P	VBM3	+\$99
60"	24"	15	\$850	VTM3	+\$57	VCEL3	VCEH3	VCEK3	N/A	VCMDP	N/A	VFS2P	VBM3	+\$99
66"	12"	9	\$455	VTM3	+\$57	VCEL3	VCEH3	VCEK3	N/A	VCMDP	N/A	VFS2P	VBM3	+\$99
66"	16"	11	\$590	VTM3	+\$57	VCEL3	VCEH3	VCEK3	N/A	VCMDP	N/A	VFS2P	VBM3	+\$99
66"	18"	13	\$840	VTM3	+\$57	VCEL3	VCEH3	VCEK3	N/A	VCMDP	N/A	VFS2P	VBM3	+\$99
66"	24"	16	\$855	VTM3	+\$57	VCEL3	VCEH3	VCEK3	N/A	VCMDP	N/A	VFS2P	VBM3	+\$99
72"	12"	10	\$465	VTM3	+\$57	VCEL3	VCEH3	VCEK3	N/A	VCMDP	N/A	VFS2P	VBM3	+\$99
72"	16"	12	\$595	VTM3	+\$57	VCEL3	VCEH3	VCEK3	N/A	VCMDP	N/A	VFS2P	VBM3	+\$99
72"	18"	14	\$845	VTM3	+\$57	VCEL3	VCEH3	VCEK3	N/A	VCMDP	N/A	VFS2P	VBM3	+\$99
72"	24"	17	\$860	VTM3	+\$57	VCEL3	VCEH3	VCEK3	N/A	VCMDP	N/A	VFS2P	VBM3	+\$99

NOTE:

All pricing in USD

Quantity of mounting clamps noted as last number in SKU

Middle Clamp (VCMS) and Middle Clamp Knob (VCMKS) kits include 1 clamp and 1 metal stability plate

* Dimension is 1" less than width of desk to allow for rear panel (see page 13)

Middle Clamp Double (VCMD) includes 2 clamps

Middle Clamp Double with Pad (VCMDP) for panel widths 54" and larger, includes 2 clamps and 1 stability plate



ENCLAVE™ PANEL - TRUBRITE™ WHITEBOARD



ENCLAVE™ PANEL
Style - TruBrite™ Whiteboard
(WB)



Shown with Edge
Clamp - Knob (VCEK2)



Shown with Free Standing
Feet (VFS2)

MOUNTING OPTIONS

FAD-WB				Top Mount	Price	Edge Clamp Lever	Edge Clamp Hex	Edge Clamp Knob	Middle Clamp	Middle Clamp Double	Middle Clamp Knob	Free Standing	Bench Mount	Price
Width	Height	Weight (lbs)	Base Price											
17" *	12"	4	\$135	VTM2	+\$38	VCEL2	VCEH2	VCEK2	VCMS	VCMD	VCMKS	VFS2	VBM2	+\$66
17" *	16"	5	\$155	VTM2	+\$38	VCEL2	VCEH2	VCEK2	VCMS	VCMD	VCMKS	VFS2	VBM2	+\$66
17" *	18"	5	\$180	VTM2	+\$38	VCEL2	VCEH2	VCEK2	VCMS	VCMD	VCMKS	VFS2	VBM2	+\$66
17" *	24"	6	\$195	VTM2	+\$38	VCEL2	VCEH2	VCEK2	VCMS	VCMD	VCMKS	VFS2	VBM2	+\$66
23" *	12"	5	\$155	VTM2	+\$38	VCEL2	VCEH2	VCEK2	VCMS	VCMD	VCMKS	VFS2	VBM2	+\$66
23" *	16"	5	\$180	VTM2	+\$38	VCEL2	VCEH2	VCEK2	VCMS	VCMD	VCMKS	VFS2	VBM2	+\$66
23" *	18"	6	\$195	VTM2	+\$38	VCEL2	VCEH2	VCEK2	VCMS	VCMD	VCMKS	VFS2	VBM2	+\$66
23" *	24"	7	\$225	VTM2	+\$38	VCEL2	VCEH2	VCEK2	VCMS	VCMD	VCMKS	VFS2	VBM2	+\$66
29" *	12"	5	\$185	VTM2	+\$38	VCEL2	VCEH2	VCEK2	VCMS	VCMD	VCMKS	VFS2	VBM2	+\$66
29" *	16"	6	\$210	VTM2	+\$38	VCEL2	VCEH2	VCEK2	VCMS	VCMD	VCMKS	VFS2	VBM2	+\$66
29" *	18"	7	\$225	VTM2	+\$38	VCEL2	VCEH2	VCEK2	VCMS	VCMD	VCMKS	VFS2	VBM2	+\$66
29" *	24"	8	\$270	VTM2	+\$38	VCEL2	VCEH2	VCEK2	VCMS	VCMD	VCMKS	VFS2	VBM2	+\$66
36"	12"	6	\$210	VTM2	+\$38	VCEL2	VCEH2	VCEK2	N/A	VCMD	N/A	VFS2	VBM2	+\$66
36"	16"	7	\$250	VTM2	+\$38	VCEL2	VCEH2	VCEK2	N/A	VCMD	N/A	VFS2	VBM2	+\$66
36"	18"	8	\$290	VTM2	+\$38	VCEL2	VCEH2	VCEK2	N/A	VCMD	N/A	VFS2	VBM2	+\$66
36"	24"	10	\$310	VTM2	+\$38	VCEL2	VCEH2	VCEK2	N/A	VCMD	N/A	VFS2	VBM2	+\$66
42"	12"	7	\$230	VTM2	+\$38	VCEL2	VCEH2	VCEK2	N/A	VCMD	N/A	VFS2	VBM2	+\$66
42"	16"	8	\$275	VTM2	+\$38	VCEL2	VCEH2	VCEK2	N/A	VCMD	N/A	VFS2	VBM2	+\$66
42"	18"	9	\$305	VTM2	+\$38	VCEL2	VCEH2	VCEK2	N/A	VCMD	N/A	VFS2	VBM2	+\$66
42"	24"	11	\$355	VTM2	+\$38	VCEL2	VCEH2	VCEK2	N/A	VCMD	N/A	VFS2	VBM2	+\$66
48"	12"	7	\$255	VTM2	+\$38	VCEL2	VCEH2	VCEK2	N/A	VCMD	N/A	VFS2	VBM2	+\$66
48"	16"	9	\$290	VTM2	+\$38	VCEL2	VCEH2	VCEK2	N/A	VCMD	N/A	VFS2	VBM2	+\$66
48"	18"	10	\$320	VTM2	+\$38	VCEL2	VCEH2	VCEK2	N/A	VCMD	N/A	VFS2	VBM2	+\$66
48"	24"	12	\$370	VTM2	+\$38	VCEL2	VCEH2	VCEK2	N/A	VCMD	N/A	VFS2	VBM2	+\$66
54"	12"	8	\$330	VTM2	+\$38	VCEL2	VCEH2	VCEK2	N/A	VCMD	N/A	VFS2	VBM2	+\$66
54"	16"	10	\$390	VTM2	+\$38	VCEL2	VCEH2	VCEK2	N/A	VCMD	N/A	VFS2	VBM2	+\$66
54"	18"	11	\$495	VTM2	+\$38	VCEL2	VCEH2	VCEK2	N/A	VCMD	N/A	VFS2	VBM2	+\$66
54"	24"	14	\$515	VTM2	+\$38	VCEL2	VCEH2	VCEK2	N/A	VCMD	N/A	VFS2	VBM2	+\$66
60"	12"	8	\$340	VTM3	+\$57	VCEL3	VCEH3	VCEK3	N/A	VCMDP	N/A	VFS2P	VBM3	+\$99
60"	16"	11	\$405	VTM3	+\$57	VCEL3	VCEH3	VCEK3	N/A	VCMDP	N/A	VFS2P	VBM3	+\$99
60"	18"	12	\$510	VTM3	+\$57	VCEL3	VCEH3	VCEK3	N/A	VCMDP	N/A	VFS2P	VBM3	+\$99
60"	24"	15	\$530	VTM3	+\$57	VCEL3	VCEH3	VCEK3	N/A	VCMDP	N/A	VFS2P	VBM3	+\$99
66"	12"	9	\$355	VTM3	+\$57	VCEL3	VCEH3	VCEK3	N/A	VCMDP	N/A	VFS2P	VBM3	+\$99
66"	16"	11	\$420	VTM3	+\$57	VCEL3	VCEH3	VCEK3	N/A	VCMDP	N/A	VFS2P	VBM3	+\$99
66"	18"	13	\$525	VTM3	+\$57	VCEL3	VCEH3	VCEK3	N/A	VCMDP	N/A	VFS2P	VBM3	+\$99
66"	24"	16	\$545	VTM3	+\$57	VCEL3	VCEH3	VCEK3	N/A	VCMDP	N/A	VFS2P	VBM3	+\$99
72"	12"	10	\$385	VTM3	+\$57	VCEL3	VCEH3	VCEK3	N/A	VCMDP	N/A	VFS2P	VBM3	+\$99
72"	16"	12	\$455	VTM3	+\$57	VCEL3	VCEH3	VCEK3	N/A	VCMDP	N/A	VFS2P	VBM3	+\$99
72"	18"	14	\$570	VTM3	+\$57	VCEL3	VCEH3	VCEK3	N/A	VCMDP	N/A	VFS2P	VBM3	+\$99
72"	24"	17	\$595	VTM3	+\$57	VCEL3	VCEH3	VCEK3	N/A	VCMDP	N/A	VFS2P	VBM3	+\$99

NOTE:

All pricing in USD

Quantity of mounting clamps noted as last number in SKU

Middle Clamp (VCMS) and Middle Clamp Knob (VCMKS) kits include 1 clamp and 1 metal stability plate

* Dimension is 1" less than width of desk to allow for rear panel (see page 13)

Middle Clamp Double (VCMD) includes 2 clamps

Middle Clamp Double with Pad (VCMDP) for panel widths 54" and larger, includes 2 clamps and 1 stability plate



ENCLAVE™ PANEL - FABRIC FOLD

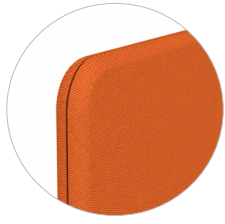

ENCLAVE™ PANEL
Style - Fabric Fold (FF)

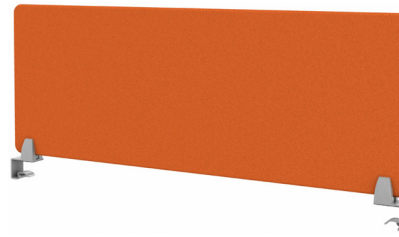

Shown with Middle Clamp - Double (VCMD)

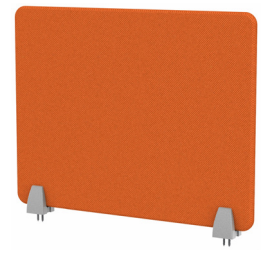

Shown with Top Mount (VTM2)

MOUNTING OPTIONS

FAD-FF					Top Mount	Price	Edge Clamp Lever	Edge Clamp Hex	Edge Clamp Knob	Middle Clamp	Middle Clamp Double	Middle Clamp Knob	Free Standing	Bench Mount	Price
Width	Height	Weight (lbs)	100 Series	200 Series											
17" *	12"	4	\$145	\$155	VTM2	+\$38	VCEL2	VCEH2	VCEK2	VCMS	VCMD	VCMKS	VFS2	VBM2	+\$66
17" *	16"	5	\$165	\$180	VTM2	+\$38	VCEL2	VCEH2	VCEK2	VCMS	VCMD	VCMKS	VFS2	VBM2	+\$66
17" *	18"	5	\$195	\$220	VTM2	+\$38	VCEL2	VCEH2	VCEK2	VCMS	VCMD	VCMKS	VFS2	VBM2	+\$66
17" *	24"	6	\$210	\$230	VTM2	+\$38	VCEL2	VCEH2	VCEK2	VCMS	VCMD	VCMKS	VFS2	VBM2	+\$66
23" *	12"	5	\$165	\$180	VTM2	+\$38	VCEL2	VCEH2	VCEK2	VCMS	VCMD	VCMKS	VFS2	VBM2	+\$66
23" *	16"	5	\$195	\$210	VTM2	+\$38	VCEL2	VCEH2	VCEK2	VCMS	VCMD	VCMKS	VFS2	VBM2	+\$66
23" *	18"	6	\$220	\$250	VTM2	+\$38	VCEL2	VCEH2	VCEK2	VCMS	VCMD	VCMKS	VFS2	VBM2	+\$66
23" *	24"	7	\$245	\$270	VTM2	+\$38	VCEL2	VCEH2	VCEK2	VCMS	VCMD	VCMKS	VFS2	VBM2	+\$66
29" *	12"	5	\$190	\$205	VTM2	+\$38	VCEL2	VCEH2	VCEK2	VCMS	VCMD	VCMKS	VFS2	VBM2	+\$66
29" *	16"	6	\$220	\$240	VTM2	+\$38	VCEL2	VCEH2	VCEK2	VCMS	VCMD	VCMKS	VFS2	VBM2	+\$66
29" *	18"	7	\$255	\$285	VTM2	+\$38	VCEL2	VCEH2	VCEK2	VCMS	VCMD	VCMKS	VFS2	VBM2	+\$66
29" *	24"	8	\$285	\$315	VTM2	+\$38	VCEL2	VCEH2	VCEK2	VCMS	VCMD	VCMKS	VFS2	VBM2	+\$66
36"	12"	6	\$215	\$235	VTM2	+\$38	VCEL2	VCEH2	VCEK2	N/A	VCMD	N/A	VFS2	VBM2	+\$66
36"	16"	7	\$255	\$285	VTM2	+\$38	VCEL2	VCEH2	VCEK2	N/A	VCMD	N/A	VFS2	VBM2	+\$66
36"	18"	8	\$315	\$355	VTM2	+\$38	VCEL2	VCEH2	VCEK2	N/A	VCMD	N/A	VFS2	VBM2	+\$66
36"	24"	10	\$335	\$375	VTM2	+\$38	VCEL2	VCEH2	VCEK2	N/A	VCMD	N/A	VFS2	VBM2	+\$66
42"	12"	7	\$235	\$260	VTM2	+\$38	VCEL2	VCEH2	VCEK2	N/A	VCMD	N/A	VFS2	VBM2	+\$66
42"	16"	8	\$285	\$315	VTM2	+\$38	VCEL2	VCEH2	VCEK2	N/A	VCMD	N/A	VFS2	VBM2	+\$66
42"	18"	9	\$340	\$385	VTM2	+\$38	VCEL2	VCEH2	VCEK2	N/A	VCMD	N/A	VFS2	VBM2	+\$66
42"	24"	11	\$375	\$425	VTM2	+\$38	VCEL2	VCEH2	VCEK2	N/A	VCMD	N/A	VFS2	VBM2	+\$66
48"	12"	7	\$260	\$285	VTM2	+\$38	VCEL2	VCEH2	VCEK2	N/A	VCMD	N/A	VFS2	VBM2	+\$66
48"	16"	9	\$310	\$345	VTM2	+\$38	VCEL2	VCEH2	VCEK2	N/A	VCMD	N/A	VFS2	VBM2	+\$66
48"	18"	10	\$365	\$420	VTM2	+\$38	VCEL2	VCEH2	VCEK2	N/A	VCMD	N/A	VFS2	VBM2	+\$66
48"	24"	12	\$405	\$460	VTM2	+\$38	VCEL2	VCEH2	VCEK2	N/A	VCMD	N/A	VFS2	VBM2	+\$66
54"	12"	8	\$285	\$315	VTM2	+\$38	VCEL2	VCEH2	VCEK2	N/A	VCMD	N/A	VFS2	VBM2	+\$66
54"	16"	10	\$345	\$385	VTM2	+\$38	VCEL2	VCEH2	VCEK2	N/A	VCMD	N/A	VFS2	VBM2	+\$66
54"	18"	11	\$425	\$490	VTM2	+\$38	VCEL2	VCEH2	VCEK2	N/A	VCMD	N/A	VFS2	VBM2	+\$66
54"	24"	14	\$455	\$515	VTM2	+\$38	VCEL2	VCEH2	VCEK2	N/A	VCMD	N/A	VFS2	VBM2	+\$66
60"	12"	8	\$305	\$335	VTM3	+\$57	VCEL3	VCEH3	VCEK3	N/A	VCMDP	N/A	VFS2P	VBM3	+\$99
60"	16"	11	\$365	\$410	VTM3	+\$57	VCEL3	VCEH3	VCEK3	N/A	VCMDP	N/A	VFS2P	VBM3	+\$99
60"	18"	12	\$450	\$520	VTM3	+\$57	VCEL3	VCEH3	VCEK3	N/A	VCMDP	N/A	VFS2P	VBM3	+\$99
60"	24"	15	\$485	\$550	VTM3	+\$57	VCEL3	VCEH3	VCEK3	N/A	VCMDP	N/A	VFS2P	VBM3	+\$99
66"	12"	9	\$360	\$395	VTM3	+\$57	VCEL3	VCEH3	VCEK3	N/A	VCMDP	N/A	VFS2P	VBM3	+\$99
66"	16"	11	\$435	\$480	VTM3	+\$57	VCEL3	VCEH3	VCEK3	N/A	VCMDP	N/A	VFS2P	VBM3	+\$99
66"	18"	13	\$555	\$625	VTM3	+\$57	VCEL3	VCEH3	VCEK3	N/A	VCMDP	N/A	VFS2P	VBM3	+\$99
66"	24"	16	\$585	\$660	VTM3	+\$57	VCEL3	VCEH3	VCEK3	N/A	VCMDP	N/A	VFS2P	VBM3	+\$99
72"	12"	10	\$395	\$435	VTM3	+\$57	VCEL3	VCEH3	VCEK3	N/A	VCMDP	N/A	VFS2P	VBM3	+\$99
72"	16"	12	\$480	\$535	VTM3	+\$57	VCEL3	VCEH3	VCEK3	N/A	VCMDP	N/A	VFS2P	VBM3	+\$99
72"	18"	14	\$615	\$695	VTM3	+\$57	VCEL3	VCEH3	VCEK3	N/A	VCMDP	N/A	VFS2P	VBM3	+\$99
72"	24"	17	\$655	\$730	VTM3	+\$57	VCEL3	VCEH3	VCEK3	N/A	VCMDP	N/A	VFS2P	VBM3	+\$99

NOTE:

All pricing in USD

Quantity of mounting clamps noted as last number in SKU

Middle Clamp (VCMS) and Middle Clamp Knob (VCMKS) kits include 1 clamp and 1 metal stability plate

* Dimension is 1" less than width of desk to allow for rear panel (see page 13)

Middle Clamp Double (VCMD) includes 2 clamps

Middle Clamp Double with Pad (VCMDP) for panel widths 54" and larger, includes 2 clamps and 1 stability plate

ENCLAVE™ PANEL - EDGE BAND

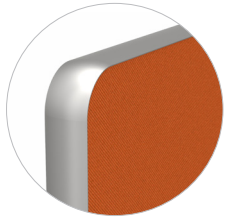

ENCLAVE™ PANEL

Style - Edge Band (EB2)

Edge Band available in:
Silver (SV)
Black (BK)
White (WT)

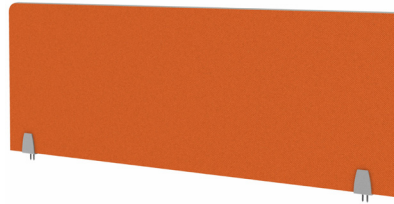

Shown with Top Mount (VTM2)

MOUNTING OPTIONS

FAD-EB2					Top Mount	Price	Edge Clamp Lever	Edge Clamp Hex	Edge Clamp Knob	Middle Clamp	Middle Clamp Double	Middle Clamp Knob	Free Standing	Bench Mount	Price
Width	Height	Weight (lbs)	100 Series	200 Series											
17" *	12"	4	\$135	\$145	VTM2	+\$38	VCEL2	VCEH2	VCEK2	VCMS	VCMD	VCMKS	VFS2P	VBM2	+\$66
17" *	16"	5	\$155	\$170	VTM2	+\$38	VCEL2	VCEH2	VCEK2	VCMS	VCMD	VCMKS	VFS2P	VBM2	+\$66
17" *	18"	5	\$180	\$200	VTM2	+\$38	VCEL2	VCEH2	VCEK2	VCMS	VCMD	VCMKS	VFS2P	VBM2	+\$66
17" *	24"	6	\$195	\$215	VTM2	+\$38	VCEL2	VCEH2	VCEK2	VCMS	VCMD	VCMKS	VFS2P	VBM2	+\$66
23" *	12"	5	\$155	\$170	VTM2	+\$38	VCEL2	VCEH2	VCEK2	VCMS	VCMD	VCMKS	VFS2P	VBM2	+\$66
23" *	16"	5	\$180	\$200	VTM2	+\$38	VCEL2	VCEH2	VCEK2	VCMS	VCMD	VCMKS	VFS2P	VBM2	+\$66
23" *	18"	6	\$210	\$235	VTM2	+\$38	VCEL2	VCEH2	VCEK2	VCMS	VCMD	VCMKS	VFS2P	VBM2	+\$66
23" *	24"	7	\$230	\$260	VTM2	+\$38	VCEL2	VCEH2	VCEK2	VCMS	VCMD	VCMKS	VFS2P	VBM2	+\$66
29" *	12"	5	\$180	\$195	VTM2	+\$38	VCEL2	VCEH2	VCEK2	VCMS	VCMD	VCMKS	VFS2P	VBM2	+\$66
29" *	16"	6	\$210	\$230	VTM2	+\$38	VCEL2	VCEH2	VCEK2	VCMS	VCMD	VCMKS	VFS2P	VBM2	+\$66
29" *	18"	7	\$240	\$275	VTM2	+\$38	VCEL2	VCEH2	VCEK2	VCMS	VCMD	VCMKS	VFS2P	VBM2	+\$66
29" *	24"	8	\$265	\$300	VTM2	+\$38	VCEL2	VCEH2	VCEK2	VCMS	VCMD	VCMKS	VFS2P	VBM2	+\$66
36"	12"	6	\$200	\$220	VTM2	+\$38	VCEL2	VCEH2	VCEK2	N/A	VCMD	N/A	VFS2P	VBM2	+\$66
36"	16"	7	\$240	\$270	VTM2	+\$38	VCEL2	VCEH2	VCEK2	N/A	VCMD	N/A	VFS2P	VBM2	+\$66
36"	18"	8	\$295	\$335	VTM2	+\$38	VCEL2	VCEH2	VCEK2	N/A	VCMD	N/A	VFS2P	VBM2	+\$66
36"	24"	10	\$315	\$355	VTM2	+\$38	VCEL2	VCEH2	VCEK2	N/A	VCMD	N/A	VFS2P	VBM2	+\$66
42"	12"	7	\$220	\$245	VTM2	+\$38	VCEL2	VCEH2	VCEK2	N/A	VCMD	N/A	VFS2P	VBM2	+\$66
42"	16"	8	\$265	\$300	VTM2	+\$38	VCEL2	VCEH2	VCEK2	N/A	VCMD	N/A	VFS2P	VBM2	+\$66
42"	18"	9	\$315	\$365	VTM2	+\$38	VCEL2	VCEH2	VCEK2	N/A	VCMD	N/A	VFS2P	VBM2	+\$66
42"	24"	11	\$355	\$400	VTM2	+\$38	VCEL2	VCEH2	VCEK2	N/A	VCMD	N/A	VFS2P	VBM2	+\$66
48"	12"	7	\$240	\$270	VTM2	+\$38	VCEL2	VCEH2	VCEK2	N/A	VCMD	N/A	VFS2P	VBM2	+\$66
48"	16"	9	\$290	\$330	VTM2	+\$38	VCEL2	VCEH2	VCEK2	N/A	VCMD	N/A	VFS2P	VBM2	+\$66
48"	18"	10	\$340	\$395	VTM2	+\$38	VCEL2	VCEH2	VCEK2	N/A	VCMD	N/A	VFS2P	VBM2	+\$66
48"	24"	12	\$380	\$435	VTM2	+\$38	VCEL2	VCEH2	VCEK2	N/A	VCMD	N/A	VFS2P	VBM2	+\$66
54"	12"	8	\$265	\$295	VTM2	+\$38	VCEL2	VCEH2	VCEK2	N/A	VCMD	N/A	VFS2P	VBM2	+\$66
54"	16"	10	\$320	\$360	VTM2	+\$38	VCEL2	VCEH2	VCEK2	N/A	VCMD	N/A	VFS2P	VBM2	+\$66
54"	18"	11	\$395	\$460	VTM2	+\$38	VCEL2	VCEH2	VCEK2	N/A	VCMD	N/A	VFS2P	VBM2	+\$66
54"	24"	14	\$430	\$490	VTM2	+\$38	VCEL2	VCEH2	VCEK2	N/A	VCMD	N/A	VFS2P	VBM2	+\$66
60"	12"	8	\$285	\$315	VTM3	+\$57	VCEL3	VCEH3	VCEK2	N/A	VCMD	N/A	VFS2P	VBM3	+\$99
60"	16"	11	\$340	\$385	VTM3	+\$57	VCEL3	VCEH3	VCEK2	N/A	VCMD	N/A	VFS2P	VBM3	+\$99
60"	18"	12	\$420	\$490	VTM3	+\$57	VCEL3	VCEH3	VCEK2	N/A	VCMD	N/A	VFS2P	VBM3	+\$99
60"	24"	15	\$455	\$520	VTM3	+\$57	VCEL3	VCEH3	VCEK2	N/A	VCMD	N/A	VFS2P	VBM3	+\$99
66"	12"	9	\$320	\$360	VTM3	+\$57	VCEL3	VCEH3	VCEK2	N/A	VCMD	N/A	VFS2P	VBM3	+\$99
66"	16"	11	\$390	\$440	VTM3	+\$57	VCEL3	VCEH3	VCEK2	N/A	VCMD	N/A	VFS2P	VBM3	+\$99
66"	18"	13	\$495	\$565	VTM3	+\$57	VCEL3	VCEH3	VCEK2	N/A	VCMD	N/A	VFS2P	VBM3	+\$99
66"	24"	16	\$530	\$605	VTM3	+\$57	VCEL3	VCEH3	VCEK2	N/A	VCMD	N/A	VFS2P	VBM3	+\$99
72"	12"	10	\$340	\$380	VTM3	+\$57	VCEL3	VCEH3	VCEK2	N/A	VCMD	N/A	VFS2P	VBM3	+\$99
72"	16"	12	\$410	\$465	VTM3	+\$57	VCEL3	VCEH3	VCEK2	N/A	VCMD	N/A	VFS2P	VBM3	+\$99
72"	18"	14	\$520	\$600	VTM3	+\$57	VCEL3	VCEH3	VCEK2	N/A	VCMD	N/A	VFS2P	VBM3	+\$99
72"	24"	17	\$555	\$635	VTM3	+\$57	VCEL3	VCEH3	VCEK2	N/A	VCMD	N/A	VFS2P	VBM3	+\$99

NOTE:

All pricing in USD

Quantity of mounting clamps noted as last number in SKU

Middle Clamp (VCMS) and Middle Clamp Knob (VCMKS) kits include 1 clamp and 1 metal stability plate

* Dimension is 1" less than width of desk to allow for rear panel (see page 13)

Middle Clamp Double (VCMD) includes 2 clamps

Middle Clamp Double with Pad (VCMDP) for panel widths 54" and larger, includes 2 clamps and 1 stability plate

ENCLAVE™ PANEL - METAL TRIM

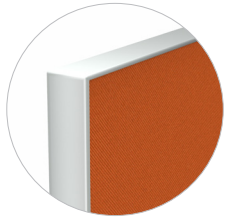

ENCLAVE™ PANEL
Style - Metal Trim
(MT2)

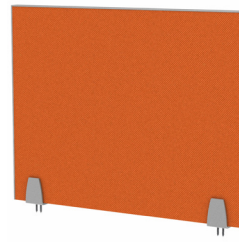

Shown with Top
Mount (VTM2)

VCMS MOUNTING OPTIONS

FAD-MT2					Top Mount	Price	MOUNTING OPTIONS										Price
Width	Height	Weight (lbs)	100 Series	200 Series			Edge Clamp Lever	Edge Clamp Hex	Edge Clamp Knob	Middle Clamp	Middle Clamp Double	Middle Clamp Knob	Free Standing	Bench Mount			
17" *	12"	4	\$145	\$155	VTM2	+\$38	VCEL2	VCEH2	VCEK2	VCMS	VCMD	UCMKS	VFS2	VBM2	+\$66		
17" *	16"	5	\$165	\$180	VTM2	+\$38	VCEL2	VCEH2	VCEK2	VCMS	VCMD	UCMKS	VFS2	VBM2	+\$66		
17" *	18"	5	\$190	\$210	VTM2	+\$38	VCEL2	VCEH2	VCEK2	VCMS	VCMD	UCMKS	VFS2	VBM2	+\$66		
17" *	24"	6	\$205	\$225	VTM2	+\$38	VCEL2	VCEH2	VCEK2	VCMS	VCMD	UCMKS	VFS2	VBM2	+\$66		
23" *	12"	5	\$165	\$180	VTM2	+\$38	VCEL2	VCEH2	VCEK2	VCMS	VCMD	UCMKS	VFS2	VBM2	+\$66		
23" *	16"	5	\$195	\$210	VTM2	+\$38	VCEL2	VCEH2	VCEK2	VCMS	VCMD	UCMKS	VFS2	VBM2	+\$66		
23" *	18"	6	\$220	\$250	VTM2	+\$38	VCEL2	VCEH2	VCEK2	VCMS	VCMD	UCMKS	VFS2	VBM2	+\$66		
23" *	24"	7	\$245	\$270	VTM2	+\$38	VCEL2	VCEH2	VCEK2	VCMS	VCMD	UCMKS	VFS2	VBM2	+\$66		
29" *	12"	5	\$190	\$205	VTM2	+\$38	VCEL2	VCEH2	VCEK2	VCMS	VCMD	UCMKS	VFS2	VBM2	+\$66		
29" *	16"	6	\$220	\$240	VTM2	+\$38	VCEL2	VCEH2	VCEK2	VCMS	VCMD	UCMKS	VFS2	VBM2	+\$66		
29" *	18"	7	\$255	\$285	VTM2	+\$38	VCEL2	VCEH2	VCEK2	VCMS	VCMD	UCMKS	VFS2	VBM2	+\$66		
29" *	24"	8	\$285	\$315	VTM2	+\$38	VCEL2	VCEH2	VCEK2	VCMS	VCMD	UCMKS	VFS2	VBM2	+\$66		
36"	12"	6	\$215	\$235	VTM2	+\$38	VCEL2	VCEH2	VCEK2	N/A	VCMD	N/A	VFS2	VBM2	+\$66		
36"	16"	7	\$255	\$280	VTM2	+\$38	VCEL2	VCEH2	VCEK2	N/A	VCMD	N/A	VFS2	VBM2	+\$66		
36"	18"	8	\$305	\$350	VTM2	+\$38	VCEL2	VCEH2	VCEK2	N/A	VCMD	N/A	VFS2	VBM2	+\$66		
36"	24"	10	\$330	\$370	VTM2	+\$38	VCEL2	VCEH2	VCEK2	N/A	VCMD	N/A	VFS2	VBM2	+\$66		
42"	12"	7	\$235	\$260	VTM2	+\$38	VCEL2	VCEH2	VCEK2	N/A	VCMD	N/A	VFS2	VBM2	+\$66		
42"	16"	8	\$280	\$315	VTM2	+\$38	VCEL2	VCEH2	VCEK2	N/A	VCMD	N/A	VFS2	VBM2	+\$66		
42"	18"	9	\$330	\$380	VTM2	+\$38	VCEL2	VCEH2	VCEK2	N/A	VCMD	N/A	VFS2	VBM2	+\$66		
42"	24"	11	\$370	\$420	VTM2	+\$38	VCEL2	VCEH2	VCEK2	N/A	VCMD	N/A	VFS2	VBM2	+\$66		
48"	12"	7	\$255	\$280	VTM2	+\$38	VCEL2	VCEH2	VCEK2	N/A	VCMD	N/A	VFS2	VBM2	+\$66		
48"	16"	9	\$310	\$345	VTM2	+\$38	VCEL2	VCEH2	VCEK2	N/A	VCMD	N/A	VFS2	VBM2	+\$66		
48"	18"	10	\$360	\$415	VTM2	+\$38	VCEL2	VCEH2	VCEK2	N/A	VCMD	N/A	VFS2	VBM2	+\$66		
48"	24"	12	\$400	\$455	VTM2	+\$38	VCEL2	VCEH2	VCEK2	N/A	VCMD	N/A	VFS2	VBM2	+\$66		
54"	12"	8	\$280	\$310	VTM2	+\$38	VCEL2	VCEH2	VCEK2	N/A	VCMD	N/A	VFS2	VBM2	+\$66		
54"	16"	10	\$340	\$380	VTM2	+\$38	VCEL2	VCEH2	VCEK2	N/A	VCMD	N/A	VFS2	VBM2	+\$66		
54"	18"	11	\$415	\$475	VTM2	+\$38	VCEL2	VCEH2	VCEK2	N/A	VCMD	N/A	VFS2	VBM2	+\$66		
54"	24"	14	\$450	\$510	VTM2	+\$38	VCEL2	VCEH2	VCEK2	N/A	VCMD	N/A	VFS2	VBM2	+\$66		
60"	12"	8	\$300	\$335	VTM2	+\$57	VCEL3	VCEH3	VCEH3	N/A	VCMDP	N/A	VFS2P	VBM2	+\$99		
60"	16"	11	\$360	\$405	VTM2	+\$57	VCEL3	VCEH3	VCEH3	N/A	VCMDP	N/A	VFS2P	VBM2	+\$99		
60"	18"	12	\$440	\$510	VTM2	+\$57	VCEL3	VCEH3	VCEH3	N/A	VCMDP	N/A	VFS2P	VBM2	+\$99		
60"	24"	15	\$475	\$545	VTM2	+\$57	VCEL3	VCEH3	VCEH3	N/A	VCMDP	N/A	VFS2P	VBM2	+\$99		
66"	12"	9	\$340	\$375	VTM2	+\$57	VCEL3	VCEH3	VCEH3	N/A	VCMDP	N/A	VFS2P	VBM2	+\$99		
66"	16"	11	\$410	\$460	VTM2	+\$57	VCEL3	VCEH3	VCEH3	N/A	VCMDP	N/A	VFS2P	VBM2	+\$99		
66"	18"	13	\$515	\$585	VTM2	+\$57	VCEL3	VCEH3	VCEH3	N/A	VCMDP	N/A	VFS2P	VBM2	+\$99		
66"	24"	16	\$555	\$625	VTM2	+\$57	VCEL3	VCEH3	VCEH3	N/A	VCMDP	N/A	VFS2P	VBM2	+\$99		
72"	12"	10	\$355	\$395	VTM2	+\$57	VCEL3	VCEH3	VCEH3	N/A	VCMDP	N/A	VFS2P	VBM2	+\$99		
72"	16"	12	\$430	\$485	VTM2	+\$57	VCEL3	VCEH3	VCEH3	N/A	VCMDP	N/A	VFS2P	VBM2	+\$99		
72"	18"	14	\$540	\$620	VTM2	+\$57	VCEL3	VCEH3	VCEH3	N/A	VCMDP	N/A	VFS2P	VBM2	+\$99		
72"	24"	17	\$580	\$660	VTM2	+\$57	VCEL3	VCEH3	VCEH3	N/A	VCMDP	N/A	VFS2P	VBM2	+\$99		

NOTE:

All pricing in USD

Quantity of mounting clamps noted as last number in SKU

Middle Clamp (VCMS) and Middle Clamp Knob (VCMKS) kits include 1 clamp and 1 metal stability plate

* Dimension is 1" less than width of desk to allow for rear panel (see page 13)

Middle Clamp Double (VCMD) includes 2 clamps

Middle Clamp Double with Pad (VCMDP) for panel widths 54" and larger, includes 2 clamps and 1 stability plate

ENCLAVE™ PANEL - ECHOSCAPE™

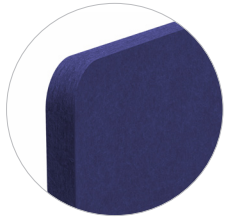

ENCLAVE™ PANEL Style - EchoScape™ (PE18)

3/4" (18mm) thickness

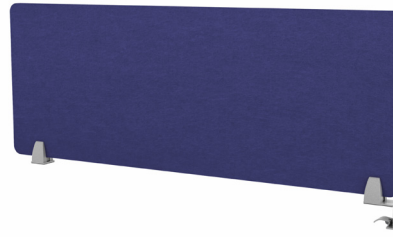

Shown with Middle
Clamp - Single (VCMS)

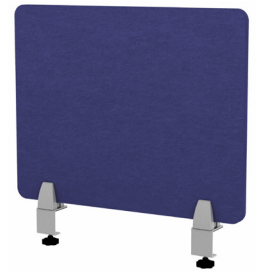

Shown with Edge
Clamp - Knob (VCEK2)

MOUNTING OPTIONS

FAD-PE18				Top Mount	Price	Edge Clamp Lever	Edge Clamp Hex	Edge Clamp Knob	Middle Clamp	Middle Clamp Double	Middle Clamp Knob	Free Standing	Bench Mount	Price
Width	Height	Weight (lbs)	Base Price											
17" *	12"	4	\$105	VTM2	+\$38	VCEL2	VCEH2	VCEK2	VCMS	VCMD	VCMKS	VFS2	VBM2	+\$66
17" *	16"	5	\$120	VTM2	+\$38	VCEL2	VCEH2	VCEK2	VCMS	VCMD	VCMKS	VFS2	VBM2	+\$66
17" *	18"	5	\$130	VTM2	+\$38	VCEL2	VCEH2	VCEK2	VCMS	VCMD	VCMKS	VFS2	VBM2	+\$66
17" *	24"	6	\$150	VTM2	+\$38	VCEL2	VCEH2	VCEK2	VCMS	VCMD	VCMKS	VFS2	VBM2	+\$66
23" *	12"	5	\$120	VTM2	+\$38	VCEL2	VCEH2	VCEK2	VCMS	VCMD	VCMKS	VFS2	VBM2	+\$66
23" *	16"	5	\$145	VTM2	+\$38	VCEL2	VCEH2	VCEK2	VCMS	VCMD	VCMKS	VFS2	VBM2	+\$66
23" *	18"	6	\$150	VTM2	+\$38	VCEL2	VCEH2	VCEK2	VCMS	VCMD	VCMKS	VFS2	VBM2	+\$66
23" *	24"	7	\$185	VTM2	+\$38	VCEL2	VCEH2	VCEK2	VCMS	VCMD	VCMKS	VFS2	VBM2	+\$66
29" *	12"	5	\$140	VTM2	+\$38	VCEL2	VCEH2	VCEK2	VCMS	VCMD	VCMKS	VFS2	VBM2	+\$66
29" *	16"	6	\$160	VTM2	+\$38	VCEL2	VCEH2	VCEK2	VCMS	VCMD	VCMKS	VFS2	VBM2	+\$66
29" *	18"	7	\$170	VTM2	+\$38	VCEL2	VCEH2	VCEK2	VCMS	VCMD	VCMKS	VFS2	VBM2	+\$66
29" *	24"	8	\$200	VTM2	+\$38	VCEL2	VCEH2	VCEK2	VCMS	VCMD	VCMKS	VFS2	VBM2	+\$66
36"	12"	6	\$160	VTM2	+\$38	VCEL2	VCEH2	VCEK2	N/A	VCMD	N/A	VFS2	VBM2	+\$66
36"	16"	7	\$195	VTM2	+\$38	VCEL2	VCEH2	VCEK2	N/A	VCMD	N/A	VFS2	VBM2	+\$66
36"	18"	8	\$210	VTM2	+\$38	VCEL2	VCEH2	VCEK2	N/A	VCMD	N/A	VFS2	VBM2	+\$66
36"	24"	10	\$240	VTM2	+\$38	VCEL2	VCEH2	VCEK2	N/A	VCMD	N/A	VFS2	VBM2	+\$66
42"	12"	7	\$180	VTM2	+\$38	VCEL2	VCEH2	VCEK2	N/A	VCMD	N/A	VFS2	VBM2	+\$66
42"	16"	8	\$205	VTM2	+\$38	VCEL2	VCEH2	VCEK2	N/A	VCMD	N/A	VFS2	VBM2	+\$66
42"	18"	9	\$225	VTM2	+\$38	VCEL2	VCEH2	VCEK2	N/A	VCMD	N/A	VFS2	VBM2	+\$66
42"	24"	11	\$300	VTM2	+\$38	VCEL2	VCEH2	VCEK2	N/A	VCMD	N/A	VFS2	VBM2	+\$66
48"	12"	7	\$200	VTM2	+\$38	VCEL2	VCEH2	VCEK2	N/A	VCMD	N/A	VFS2	VBM2	+\$66
48"	16"	9	\$240	VTM2	+\$38	VCEL2	VCEH2	VCEK2	N/A	VCMD	N/A	VFS2	VBM2	+\$66
48"	18"	10	\$265	VTM2	+\$38	VCEL2	VCEH2	VCEK2	N/A	VCMD	N/A	VFS2	VBM2	+\$66
48"	24"	12	\$310	VTM2	+\$38	VCEL2	VCEH2	VCEK2	N/A	VCMD	N/A	VFS2	VBM2	+\$66
54"	12"	8	\$215	VTM2	+\$38	VCEL2	VCEH2	VCEK2	N/A	VCMD	N/A	VFS2	VBM2	+\$66
54"	16"	10	\$255	VTM2	+\$38	VCEL2	VCEH2	VCEK2	N/A	VCMD	N/A	VFS2	VBM2	+\$66
54"	18"	11	\$280	VTM2	+\$38	VCEL2	VCEH2	VCEK2	N/A	VCMD	N/A	VFS2	VBM2	+\$66
54"	24"	14	\$325	VTM2	+\$38	VCEL2	VCEH2	VCEK2	N/A	VCMD	N/A	VFS2	VBM2	+\$66
60"	12"	8	\$225	VTM3	+\$57	VCEL3	VCEH3	VCEK3	N/A	VCMDP	N/A	VFS2P	VBM3	+\$99
60"	16"	11	\$265	VTM3	+\$57	VCEL3	VCEH3	VCEK3	N/A	VCMDP	N/A	VFS2P	VBM3	+\$99
60"	18"	12	\$290	VTM3	+\$57	VCEL3	VCEH3	VCEK3	N/A	VCMDP	N/A	VFS2P	VBM3	+\$99
60"	24"	15	\$340	VTM3	+\$57	VCEL3	VCEH3	VCEK3	N/A	VCMDP	N/A	VFS2P	VBM3	+\$99
66"	12"	9	\$280	VTM3	+\$57	VCEL3	VCEH3	VCEK3	N/A	VCMDP	N/A	VFS2P	VBM3	+\$99
66"	16"	11	\$370	VTM3	+\$57	VCEL3	VCEH3	VCEK3	N/A	VCMDP	N/A	VFS2P	VBM3	+\$99
66"	18"	13	\$375	VTM3	+\$57	VCEL3	VCEH3	VCEK3	N/A	VCMDP	N/A	VFS2P	VBM3	+\$99
66"	24"	16	\$490	VTM3	+\$57	VCEL3	VCEH3	VCEK3	N/A	VCMDP	N/A	VFS2P	VBM3	+\$99
72"	12"	10	\$290	VTM3	+\$57	VCEL3	VCEH3	VCEK3	N/A	VCMDP	N/A	VFS2P	VBM3	+\$99
72"	16"	12	\$380	VTM3	+\$57	VCEL3	VCEH3	VCEK3	N/A	VCMDP	N/A	VFS2P	VBM3	+\$99
72"	18"	14	\$390	VTM3	+\$57	VCEL3	VCEH3	VCEK3	N/A	VCMDP	N/A	VFS2P	VBM3	+\$99
72"	24"	17	\$505	VTM3	+\$57	VCEL3	VCEH3	VCEK3	N/A	VCMDP	N/A	VFS2P	VBM3	+\$99

NOTE:

All pricing in USD

Quantity of mounting clamps noted as last number in SKU

Middle Clamp (VCMS) and Middle Clamp Knob (VCMKS) kits include 1 clamp and 1 metal stability plate

Middle Clamp Double (VCMD) includes 2 clamps

* Dimension is 1" less than width of desk to allow for rear panel (see page 13)

Middle Clamp Double with Pad (VCMDP) for panel widths 54" and larger, includes 2 clamps and 1 stability plate

EchoScape™ 3/4" (18mm) panel style comes with the V-Mount only

Sound Absorbent - EchoScape™ 3/4" (18mm), is rated at .9 NRC

Eco-Friendly - EchoScape™ is made from 60% post-consumer reclaimed plastic water bottles, is VOC-free, and 100% recyclable



CORE MATERIAL OPTIONS

FABRIC SERIES 100 (F1_)

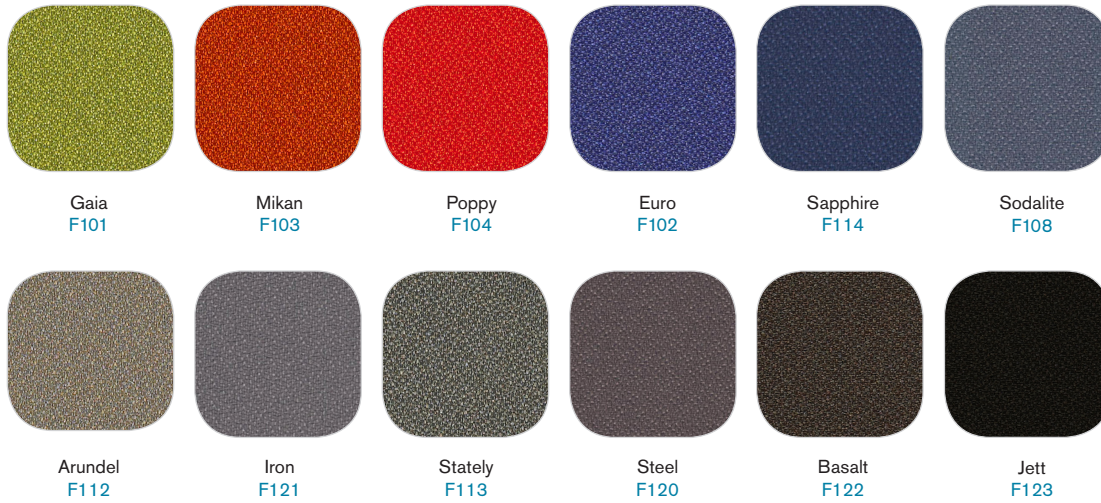

FABRIC SERIES 200 (F2_)

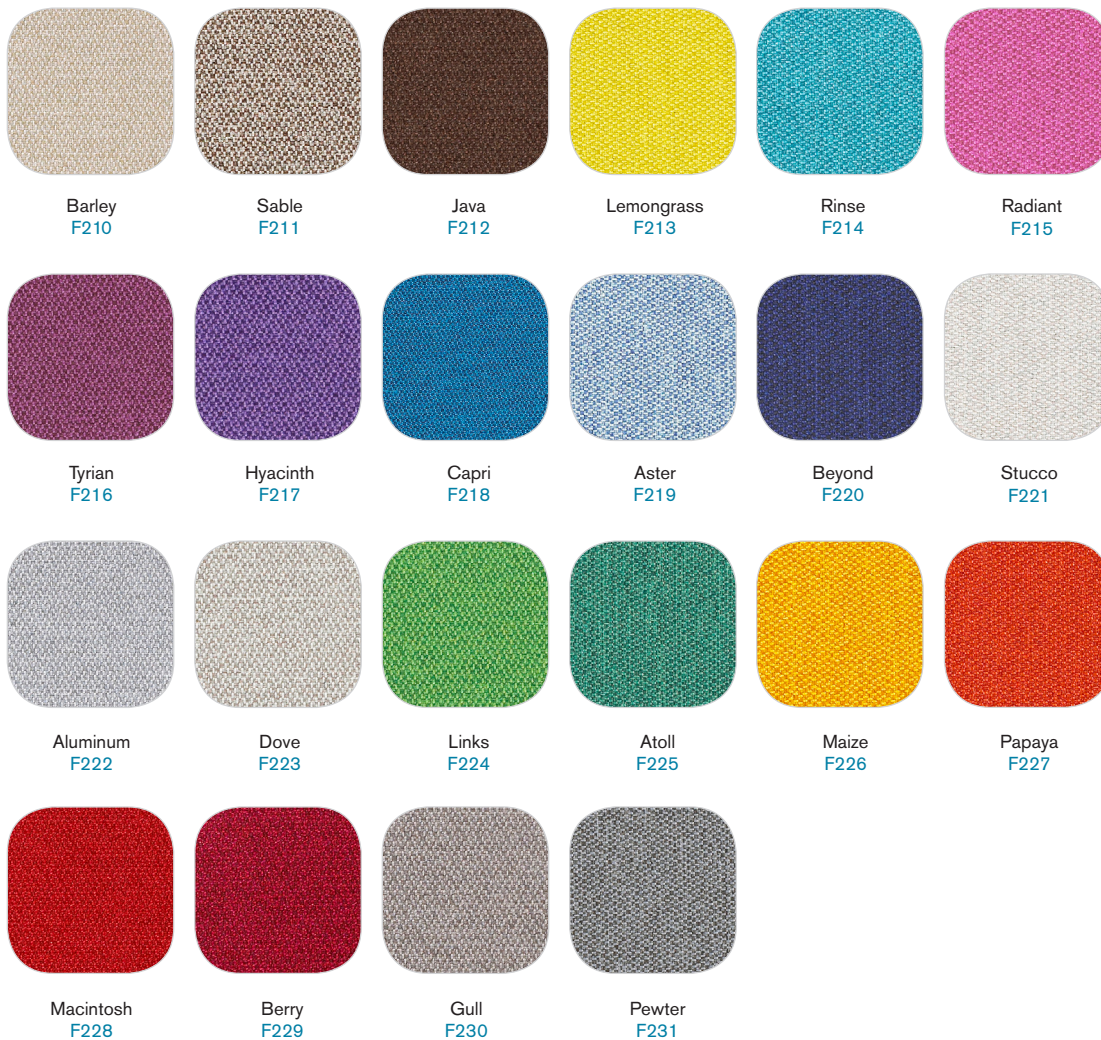

COLORED FROSTED ACRYLICS (A1_)

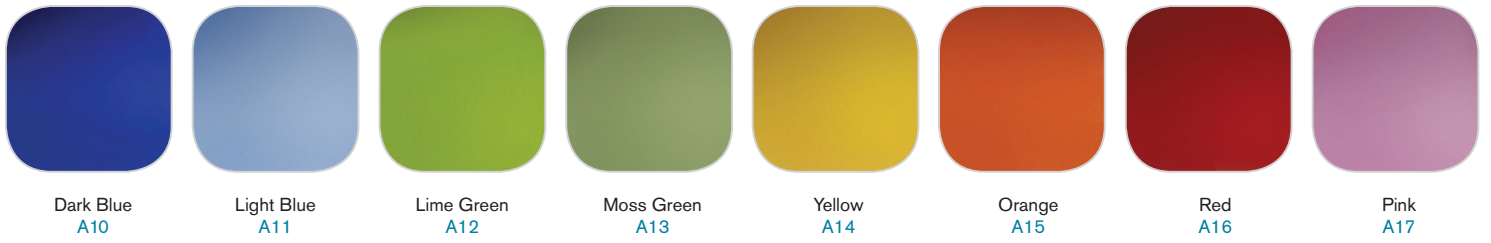

ECHOSCAPE™ 3/4" (18MM) (P1_)



EDGE BAND COLORS

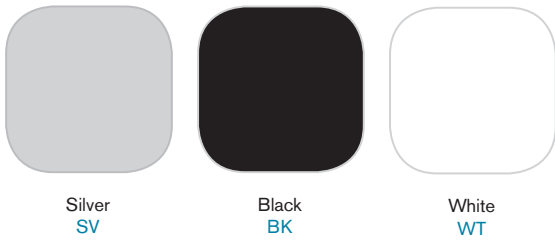

METAL TRIM COLOR



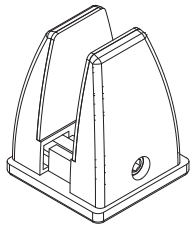

VCMP CLAMP WITH STABILITY PAD

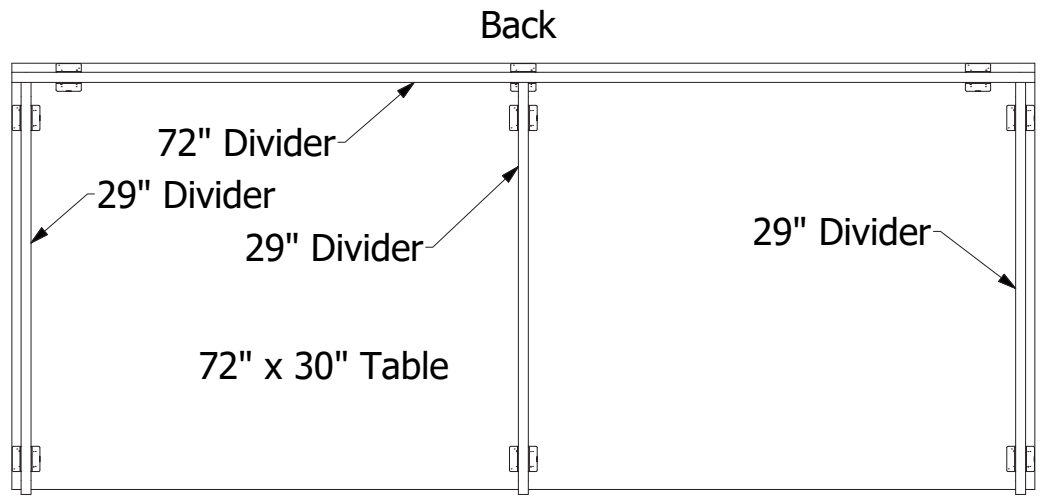

Front (user side)

